

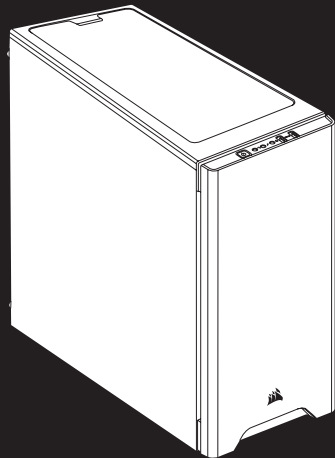

# 275Q



CARBIDE SERIES®

# 275Q

MID-TOWER GAMING CASE



WEB: [corsair.com](http://corsair.com)

PHONE: (888) 222-4346

WARRANTY: [www.corsair.com/  
support/warranty](http://www.corsair.com/support/warranty)

SUPPORT: [support.corsair.com](http://support.corsair.com)

BLOG: [corsair.com/blog](http://corsair.com/blog)

FORUM: [forum.corsair.com](http://forum.corsair.com)

YOUTUBE: [youtube.com/corsairhowto](http://youtube.com/corsairhowto)

© 2018-2019 CORSAIR MEMORY, Inc. All rights reserved. CORSAIR and the sails logo are registered trademarks in the United States and/or other countries. All other trademarks are the property of their respective owners. Product may vary slightly from those pictured. 49-001752 AD





ENGLISH.....	1
FRANÇAIS.....	9
DEUTSCH.....	17
ITALIANO.....	25
ESPAÑOL.....	33
РУССКИЙ.....	41
PORTUGUÊS.....	49

## CASE SPECIFICATIONS

Length .....	460mm
Width .....	211mm
Height .....	455mm
Maximum GPU length .....	370mm
Maximum CPU height .....	170mm
Maximum PSU length .....	180mm

### Fan locations:

Front .....	3x120mm / 2x140mm
Top .....	2x120mm / 1x140mm
Rear .....	120mm

### Radiator compatibility:

Front .....	360mm / 280mm
Top .....	240mm
Rear .....	120mm

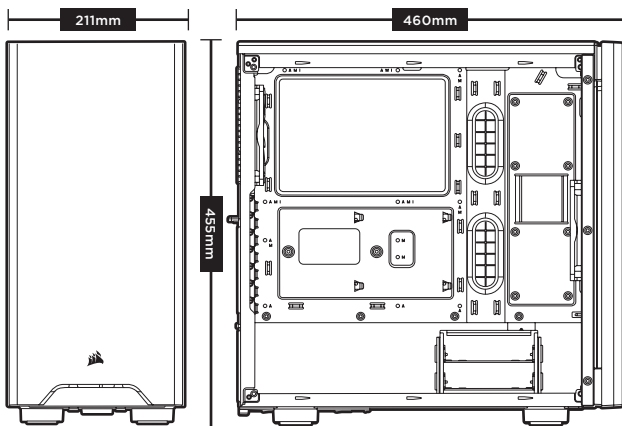

## ACCESSORY KIT CONTENTS

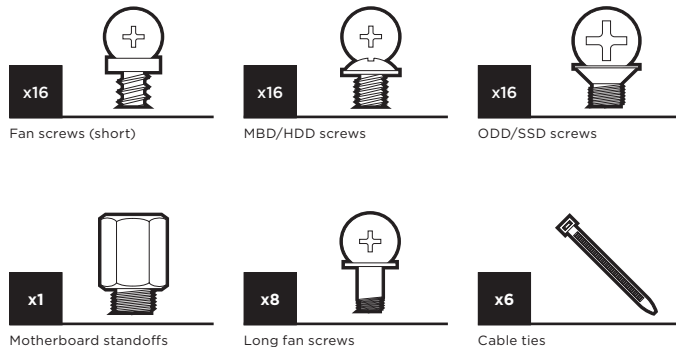

## CASE FEATURES

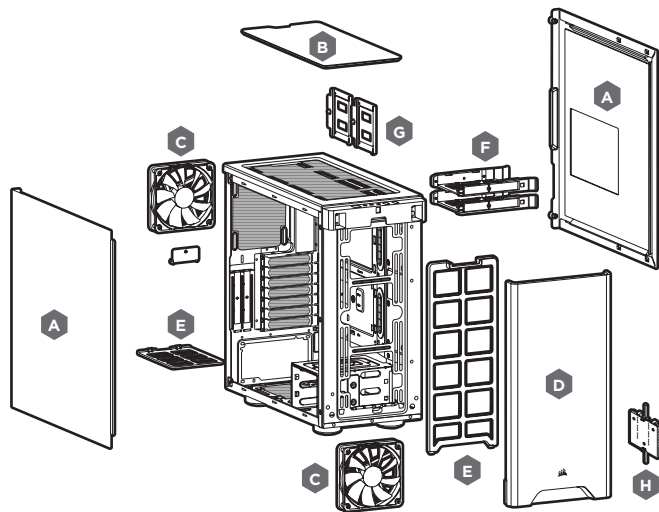

A – SOLID SIDE PANEL WITH NOISE DAMPING MATERIAL

B – SOLID TOP PANEL WITH NOISE DAMPING MATERIAL

C – 2x 120mm FANS

D – FRONT BEZEL

E – DUST FILTERS

F – HDD CAGE AND TRAYS

G – REMOVABLE SSD TRAYS

H – FAN PWM REPEATER

## REMOVING THE SIDE PANELS

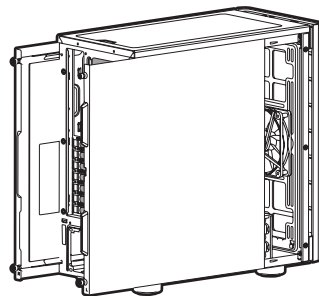

## INSTALLING THE MOTHERBOARD

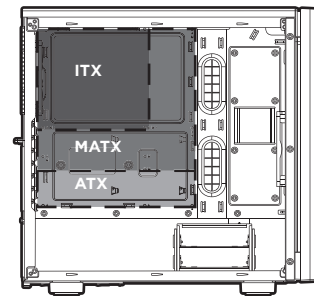

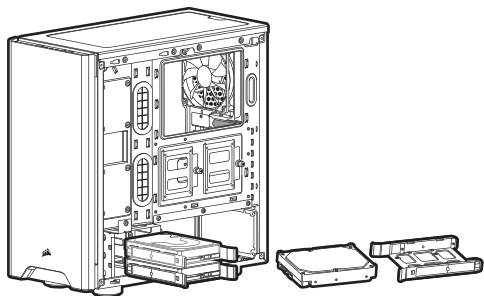
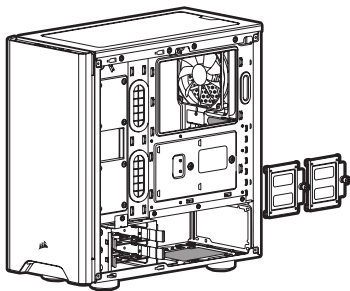
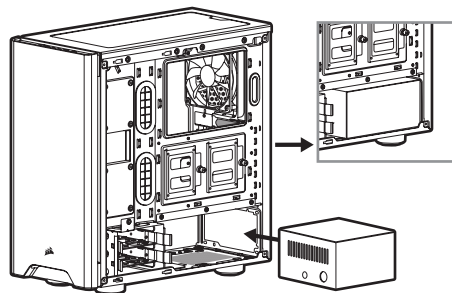
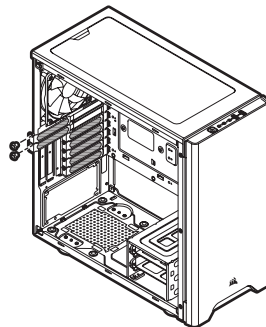
**INSTALLING HDDs****INSTALLING SSDs****INSTALLING PSU****INSTALLING PCI-e CARDS**

## REMOVING THE FRONT BEZEL

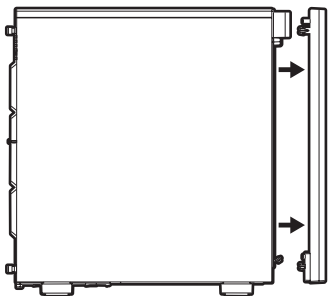

## INSTALLING THE FRONT I/O CONNECTORS

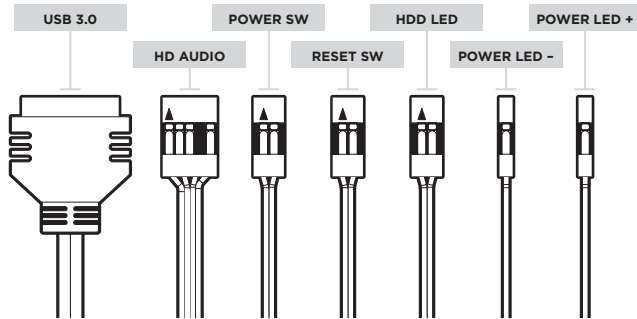

## FAN PWM REPEATER

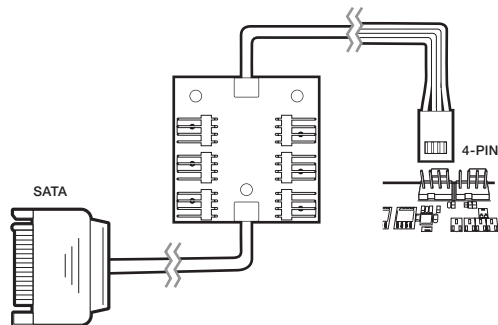

## FREQUENTLY ASKED QUESTIONS

1. Does the polarity matter with the I/O panel's power and reset header?  
No, only the LED headers.
2. Who should I contact if I received my case damaged or one of the fans is no longer working?  
Please go to [support.corsair.com](http://support.corsair.com) and request an RMA so that we can replace the damaged part(s).
3. Where can I mount a fan?

Fan mount locations	
Front	3x120mm / 2x140mm
Top	2x120mm / 1x140mm
Rear	120mm

To learn more about this case visit the product page at [corsair.com](http://corsair.com).

## SPÉCIFICATIONS DU BOÎTIER

Longueur.....	460mm
Largeur.....	211mm
Hauteur.....	455mm
Longueur maximale de carte graphique.....	370mm
Hauteur maximale du processeur.....	170mm
Longueur maximale du bloc d'alimentation.....	180mm

### Emplacements des ventilateurs:

Avant.....	3x120mm / 2x140mm
Haut.....	2x120mm / 1x140mm
Arrière.....	120mm

### Compatibilité des radiateurs:

Avant.....	360mm / 280mm
Haut.....	240mm
Arrière.....	120mm

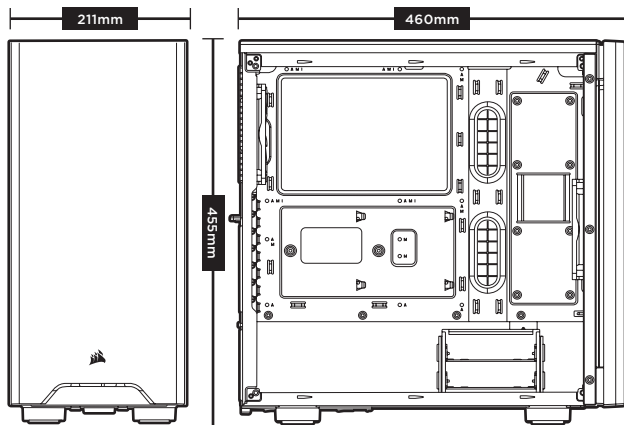

## CONTENU DU KIT D'ACCESSOIRES

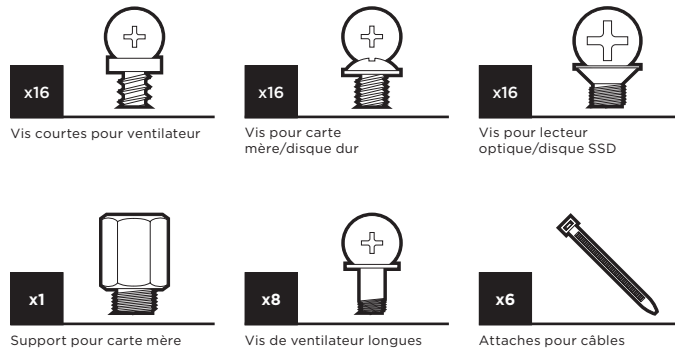

## CARACTÉRISTIQUES DU BOÎTIER

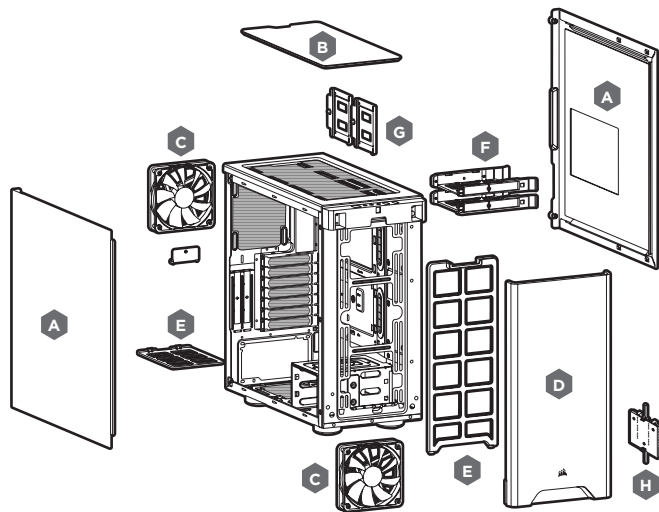

- A – PANNEAU LATÉRAL ROBUSTE AVEC  
MATERIAU INSONORISANT
- B – PANNEAU SUPÉRIEUR ROBUSTE AVEC  
MATERIAU INSONORISANT
- C – VENTILATEUR DE 2x 120mm
- D – PANNEAU AVANT

- E – FILTRE ANTI-POUSSIÈRE
- F – BAIÉ DE DISQUE DUR ET PLATEAUX
- G – PLATEAUX DE DISQUES SSD  
AMOVIBLES
- H – RÉPÉTEUR PWM POUR VENTILATEUR

## RETRAIT DES PANNEAUX LATÉRAUX

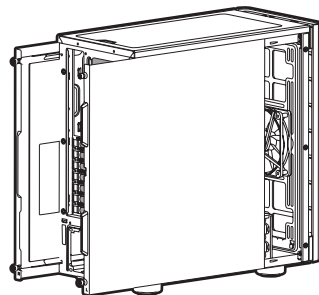

## INSTALLATION DE LA CARTE MÈRE

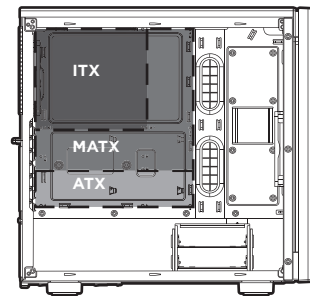



## INSTALLATION DES DISQUES DURS

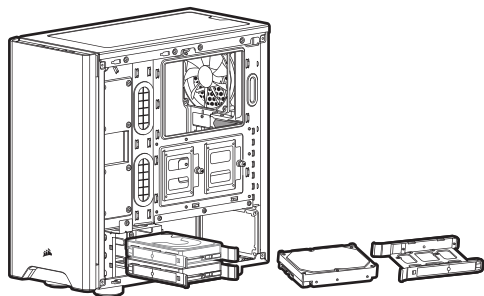

## INSTALLATION DES SSD

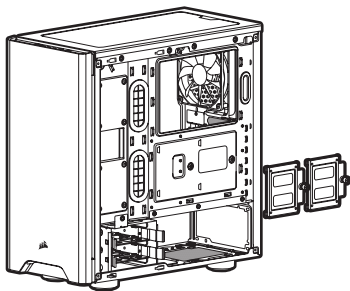

## INSTALLATION DU BLOC D'ALIMENTATION

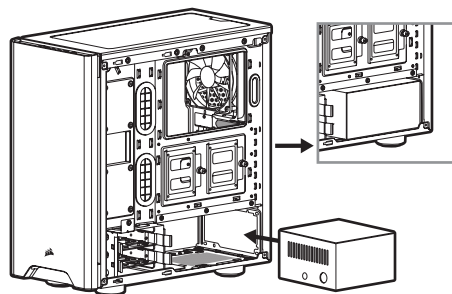

## INSTALLATION DES CARTES PCI-e

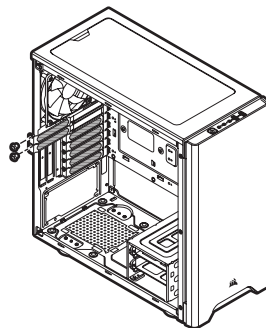

## RETRAIT DU PANNEAU AVANT

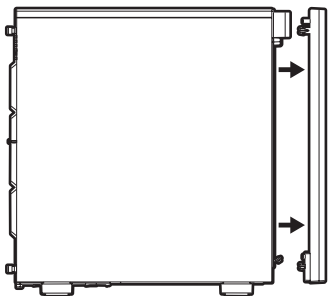

## INSTALLATION DES CONNECTEURS E/S AVANT

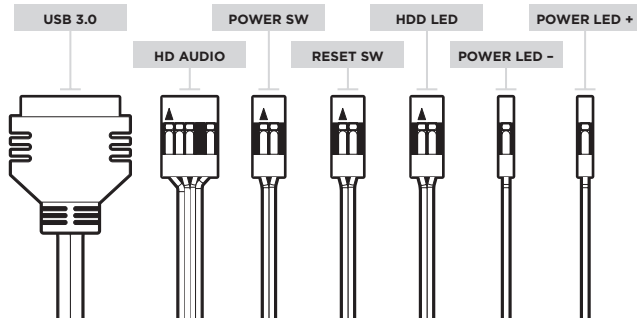

## RÉPÉTEUR PWM POUR VENTILATEUR

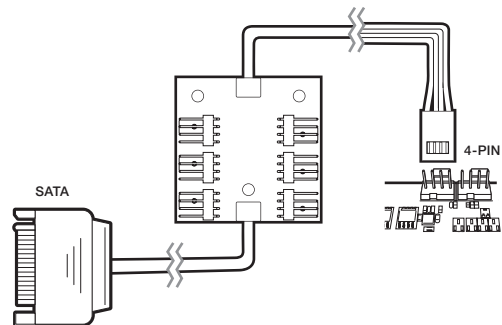

## FOIRE AUX QUESTIONS

1. La polarité est-elle importante pour l'alimentation du panneau d'E/S et le cavalier de réinitialisation?  
Non, uniquement pour les cavaliers à LED.
2. À qui dois-je m'adresser si mon boîtier est endommagé à l'arrivée ou lorsqu'un ventilateur ne fonctionne plus?  
Veuillez vous rendre sur le site [support.corsair.com](http://support.corsair.com) et demandez une RMA (autorisation de retour de marchandise) pour que nous puissions remplacer la ou les pièces endommagées.
3. Où puis-je monter un ventilateur?

Emplacements des fixations de ventilateur	
Avant	3x120mm / 2x140mm
Haut	2x120mm / 1x140mm
Arrière	120mm

Pour en savoir plus sur ce boîtier, veuillez vous rendre sur le site [corsair.com](http://corsair.com), à la page des produits.

## TECHNISCHE DATEN DES GEHÄUSES

Länge .....	460mm
Breite .....	211mm
Höhe .....	455mm
Maximale GPU-Länge .....	370mm
Maximale CPU-Höhe .....	170mm
Maximale Netzteil-Länge .....	180mm

### Lüfterpositionen:

Vorderseite .....	3x120mm / 2x140mm
Oben .....	2x120mm / 1x140mm
Rückseite .....	120mm

### Radiatorkompatibilität:

Vorderseite .....	360mm / 280mm
Oben .....	240mm
Rückseite .....	120mm

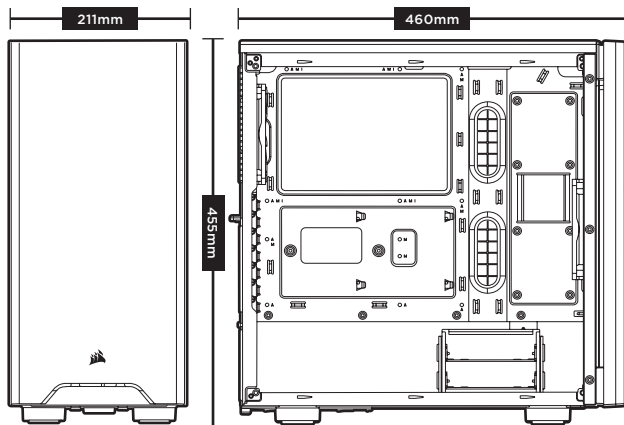

## INHALT DES ZUBEHÖRKITS

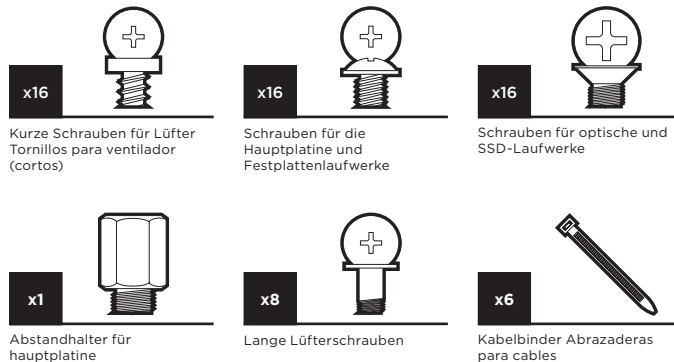

## FUNKTIONSMERKMALE DES GEHÄUSES

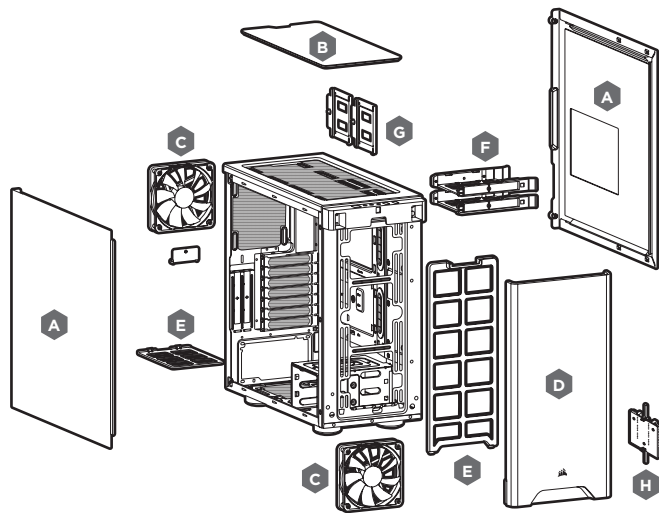

A – MASSIVE SEITENPLATTE MIT SCHALLDÄMMENDEM MATERIAL

B – MASSIVE OBERE ABDECKUNG MIT SCHALLDÄMMENDEM MATERIAL

C – 2x 120-mm-LÜFTER

D – BLENDE VORDERSEITE

E – STAUBFILTER

F – HDD-KÄFIG UND -SCHÄCHTE

G – ABNEHMBARE SSD-SCHÄCHTE

H – LÜFTER-PWM-REPEATER

## ABNEHMEN DER SEITENPLATTEN

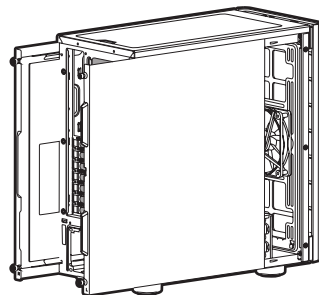

## INSTALLATION DES MOTHERBOARDS

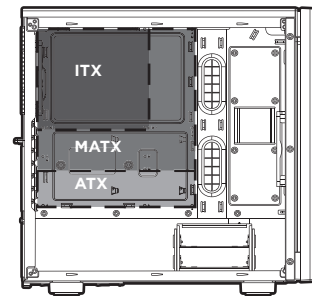

## INSTALLATION VON HDD-LAUFWERKEN

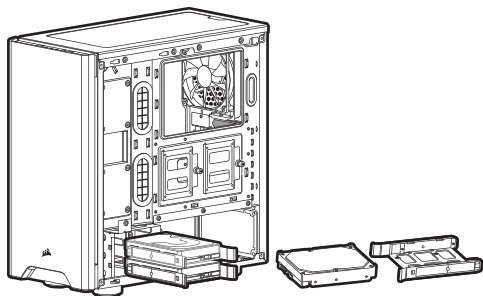

## INSTALLATION VON SSD-LAUFWERKEN

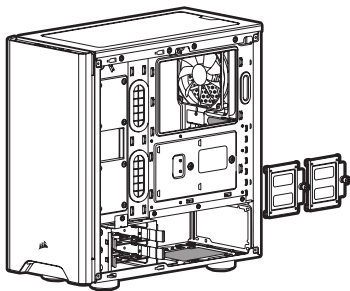

## INSTALLATION DES NETZTEILS (PSU)

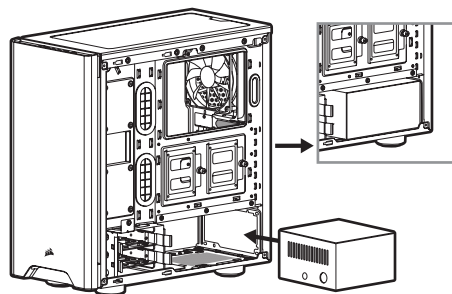

## INSTALLIEREN VON PCI-e-KARTEN

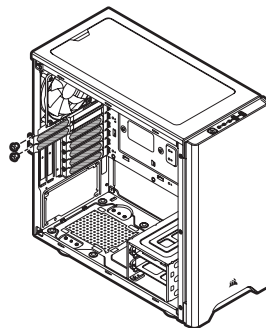

## ABNEHMEN DER VORDEREN BLENDE

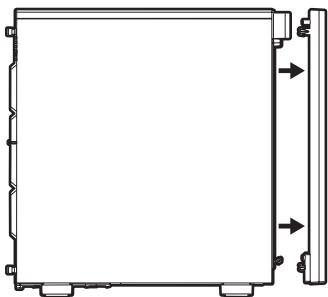

## INSTALLATION DER VORDEREN I/O -ANSCHLÜSSE

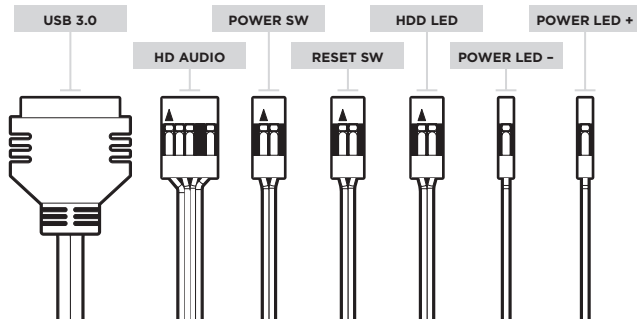

## LÜFTER-PWM-REPEATER

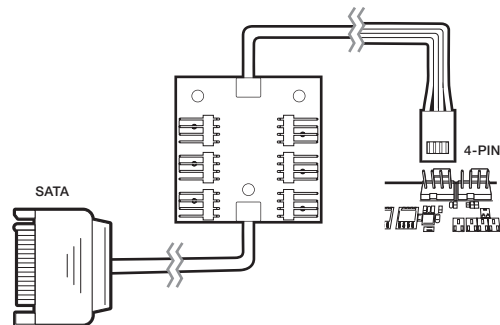

## HÄUFIG GESTELLTE FRAGEN

1. Muss bei der Ein/Austaste und dem Rücksetzschalter der I/O-Abdeckung die Polarität beachtet werden?  
Nein, nur bei den LED-Headern.
2. An wen kann ich mich wenden, wenn ich ein beschädigtes Gehäuse erhalten habe oder einer der Lüfter nicht mehr funktioniert?  
Gehen Sie zu [support.corsair.com](http://support.corsair.com) und fordern Sie eine RMA an, damit wir die beschädigten Teile ersetzen können.
3. Wo kann ich einen Lüfter anbringen?

Lüfter-Einbaupunkte	
Vorderseite	3x120mm / 2x140mm
Oberseite	2x120mm / 1x140mm
Rückseite	120mm

Weitere Informationen über dieses Gehäuse finden Sie auf der Produktseite bei [corsair.com](http://corsair.com).

## SPECIFICHE DEL PRODOTTO

Lunghezza.....	460mm
Larghezza.....	211mm
Altezza.....	455mm
Lunghezza massima scheda video.....	370mm
Altezza massima processore.....	170mm
Lunghezza massima alimentatore.....	180mm

### Posizionamento ventole:

Frontale.....	3x120mm / 2x140mm
Superiore.....	2x120mm / 1x140mm
Posteriore.....	120mm

### Posizionamento radiatore:

Frontale.....	360mm / 280mm
Superiore.....	240mm
Posteriore.....	120mm

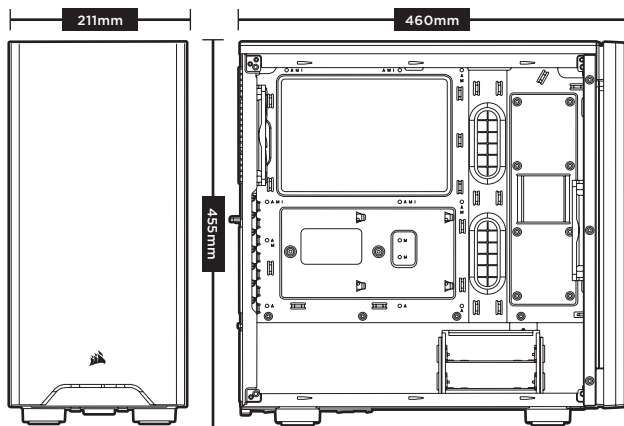

## CONTENUTO KIT ACCESSORI

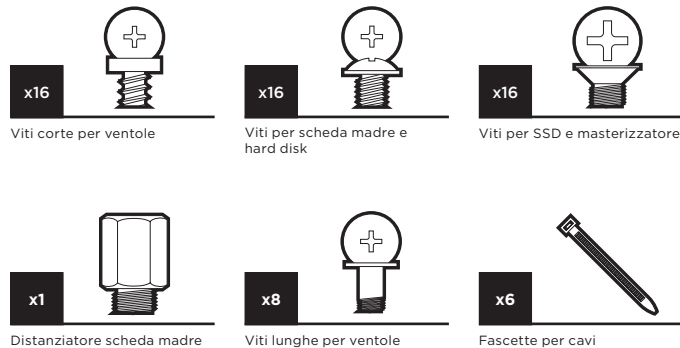

## PROPRIETÀ DEL PRODOTTO

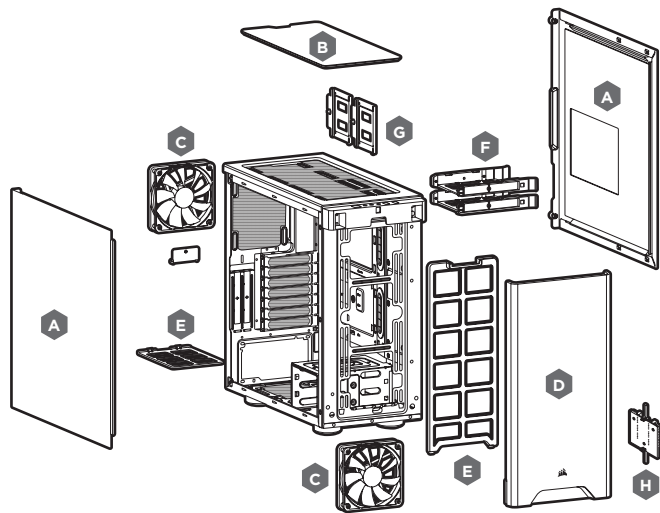

A – PANNELLO LATERALE OPACO CON MATERIALI FONOASSORBENTI

B – PANNELLO SUPERIORE OPACO CON MATERIALI FONOASSORBENTI

C – 2x VENTOLE DA 120 mm

D – PARATIA FRONTALE

E – FILTRI ANTIPOLVERE

F – CESTELLO MONTAGGIO HARD DISK

G – VASSOI PER UNITÀ SSD RIMOVIBILI

H – RIPETITORE VENTOLA PWM

## RIMOZIONE DEL PANNELLO LATERALE

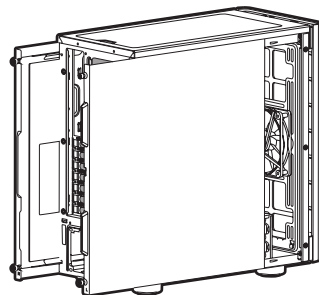

## INSTALLAZIONE SCHEDA MADRE

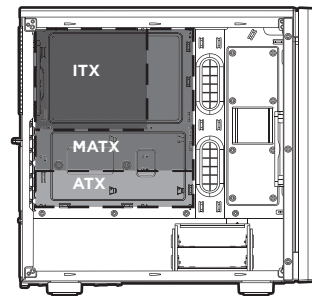



## INSTALLAZIONE HARD DISK

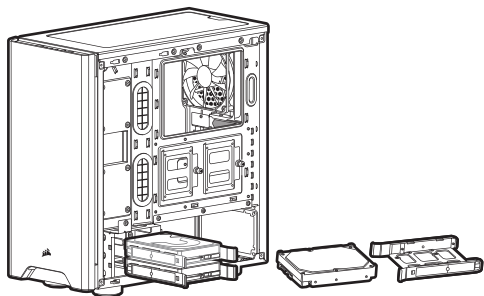

## INSTALLAZIONE SSD

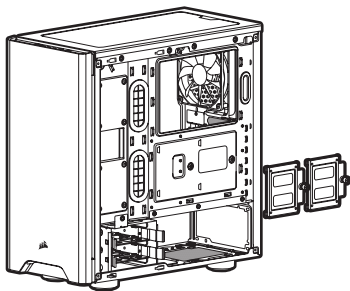

## INSTALLAZIONE ALIMENTATORE

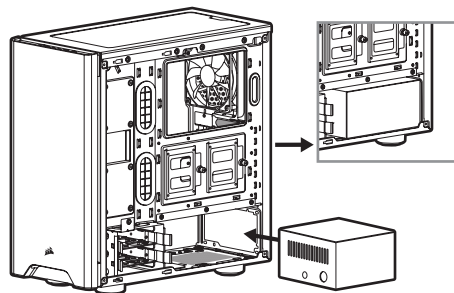

## INSTALLAZIONE PERIFERICHE PCI-e

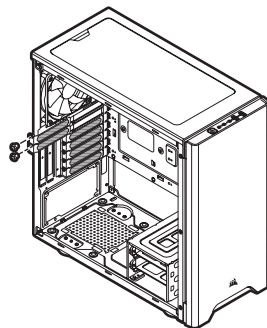

## RIMOZIONE DEL PANNELLO ANTERIORE

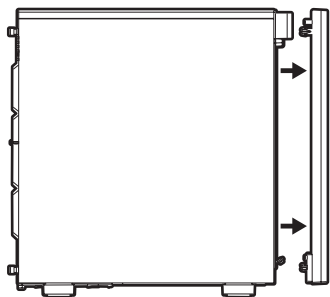

## INSTALLAZIONE CONNETTORI I/O FRONTALI

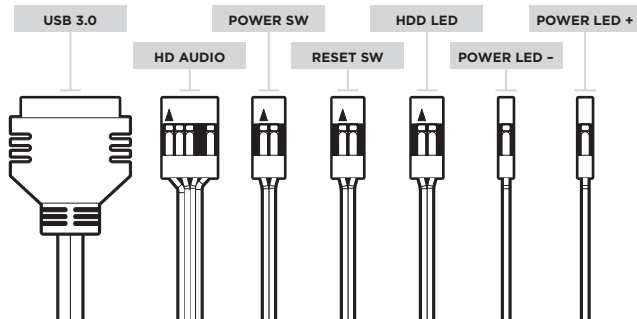

## RIPETITORE VENTOLA PWM

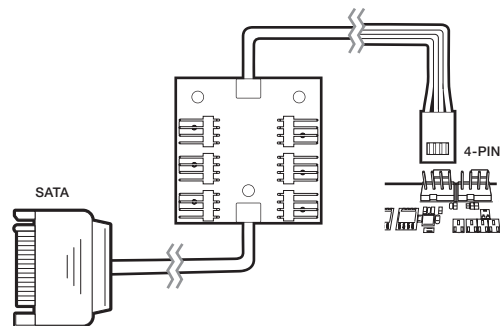

## DOMANDE PIÙ FREQUENTI

1. La corretta polarità dei connettori I/O di alimentazione e riavvio è importante?  
No, solo quella per gli indicatori LED.
2. A chi devo rivolgermi se ricevo il prodotto danneggiato oppure una delle ventole non è più funzionante?  
Per favore utilizza il modulo RMA on line support.corsair.com così che possiamo procedere alla sostituzione delle parti danneggiate.
3. In che posizione posso installare le ventole?

Posizione di installazione ventole	
Frontale	3x120mm / 2x140mm
Superiore	2x120mm / 1x140mm
Posteriore	120mm

Per ogni altra esigenza, fai riferimento alla pagina prodotto sul sito [corsair.com](http://corsair.com).

## ESPECIFICACIONES DEL CHASIS

Longitud.....	460mm
Anchura.....	211mm
Altura.....	455mm
Longitud máxima de GPU.....	370mm
Longitud máxima de CPU.....	170mm
Longitud máxima de la PSU.....	180mm

### Ubicación del ventilador:

Delantero.....	3x120mm / 2x140mm
Superior.....	2x120mm / 1x140mm
Posterior.....	120mm

### Compatibilidad del radiador:

Delantero.....	360mm / 280mm
Superior.....	240mm
Posterior.....	120mm

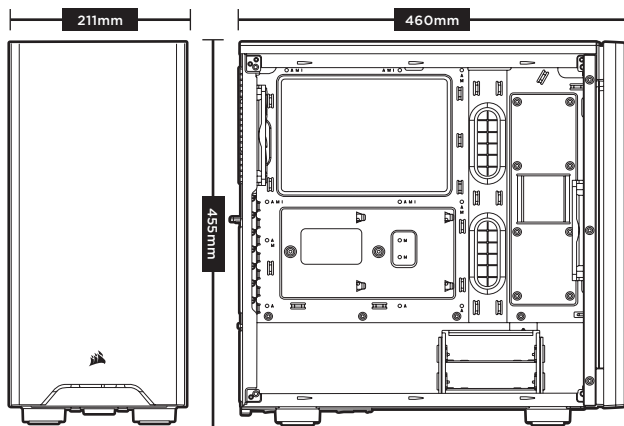

## CONTENIDO DEL KIT DE ACCESORIOS

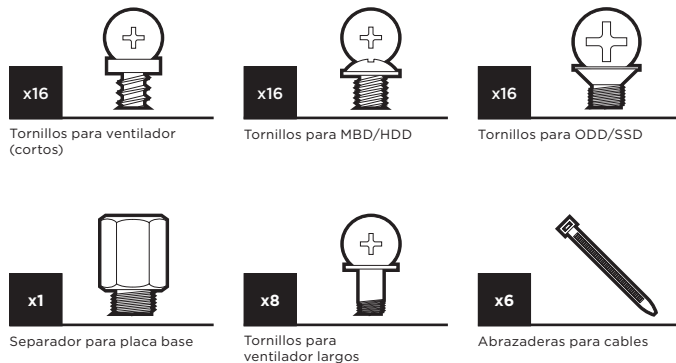

## CARACTERÍSTICAS DEL CHASIS

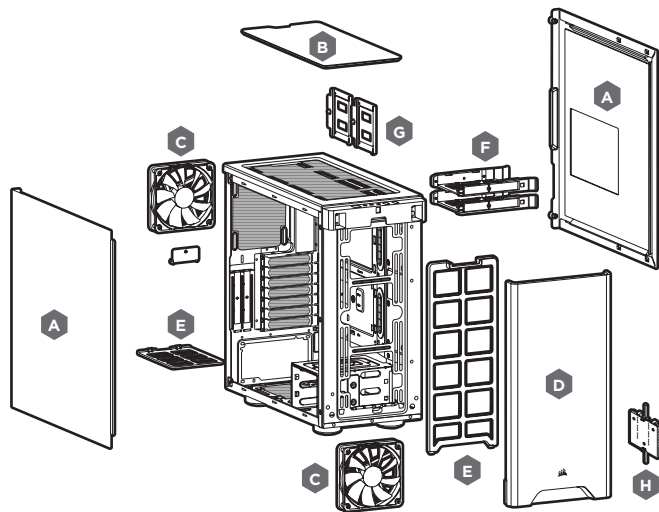

A – PANEL LATERAL SÓLIDO CON MATERIAL AMORTIGUADOR DEL RUIDO

B – PANEL SUPERIOR SÓLIDO CON MATERIAL AMORTIGUADOR DEL RUIDO

C – VENTILADOR DE 2x 120mm

D – EMBELLECEDOR FRONTAL

E – FILTRO ANTIPOLVO

F – BANDEJAS Y BAHÍA DEL HDD

G – BANDEJAS DE SSD EXTRAÍBLES

H – REPETIDOR PWM DE VENTILADOR

## RETIRADA DE LOS PANELES LATERALES

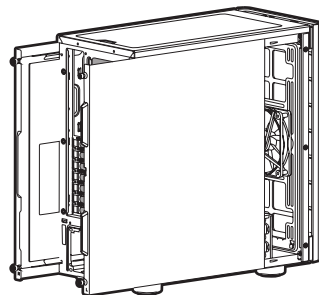

## INSTALACIÓN DE LA PLACA BASE

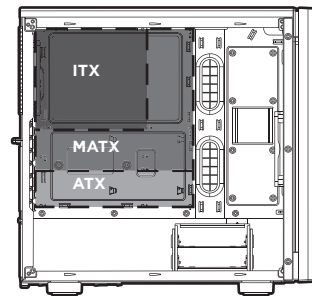

## INSTALACIÓN DE LAS UNIDADES HDD

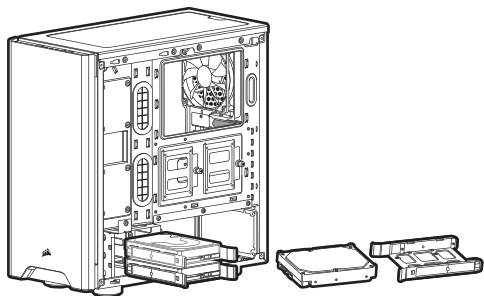

## INSTALACIÓN DE LAS UNIDADES SSD

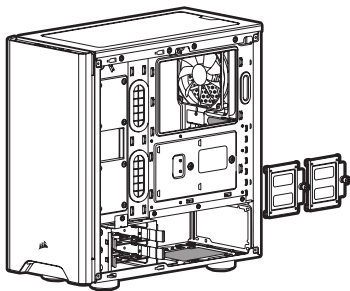

## INSTALACIÓN DE LA PSU

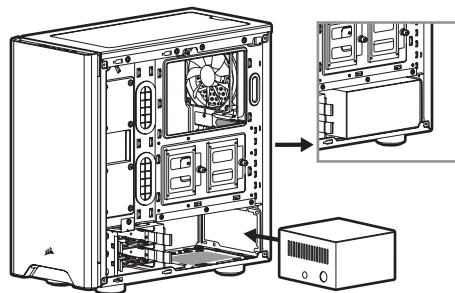

## INSTALACIÓN DE LAS TARJETAS PCI-e

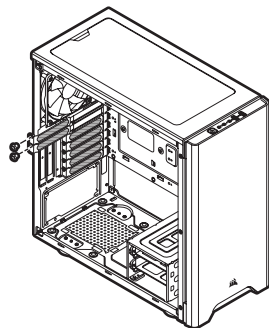

## RIMOZIONE DEL PANNELLO ANTERIORE

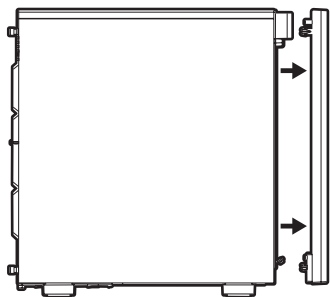

## INSTALACIÓN DE LOS CONECTORES DE E/S FRONTALES

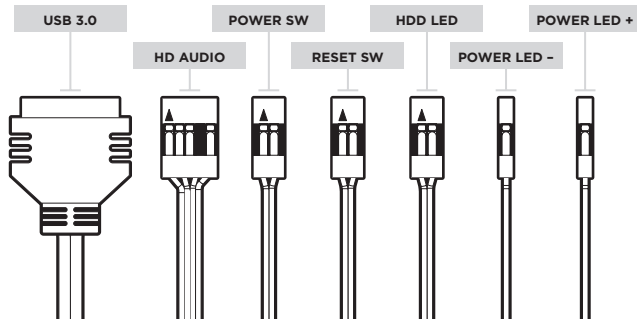

## REPETIDOR PWM DE VENTILADOR

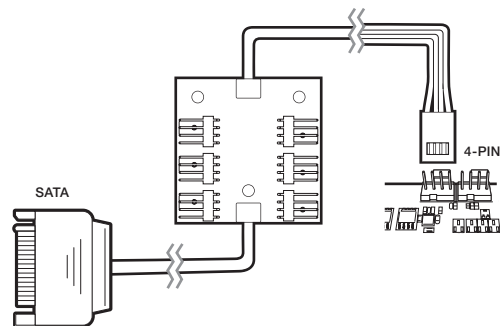

## PREGUNTAS MÁS FRECUENTES

- ¿Hay que tener en cuenta la polaridad con la alimentación y el cabezal de restablecimiento del panel de E/S?  
No, solo los cabezales LED.
- ¿Con quién debo ponerme en contacto si recibo mi chasis dañado o si uno de los ventiladores deja de funcionar?  
Vaya a [support.corsair.com](http://support.corsair.com) y solicite un RMA para que podamos reemplazar las piezas dañadas.
- ¿Dónde puedo montar un ventilador?

Puntos de montaje del ventilador	
Parte delantera	3x120mm / 2x140mm
Parte superior	2x120mm / 1x140mm
Parte posterior	120mm

Para obtener más información sobre este chasis, visite la página del producto en [corsair.com](http://corsair.com).

## ТЕХНИЧЕСКИЕ ХАРАКТЕРИСТИКИ КОРПУСА

Длина.....	460mm
Ширина.....	211mm
Высота.....	455mm
Максимальная длина графического процессора.....	370mm
Максимальная высота ЦП.....	170mm
Максимальная длина блока питания.....	180mm

### Расположение вентиляторов:

Спереди.....	3x120mm / 2x140mm
Сверху.....	2x120mm / 1x140mm
Сзади.....	120mm

### Совместимость радиаторов:

Спереди.....	360mm / 280mm
Сверху.....	240mm
Сзади.....	120mm

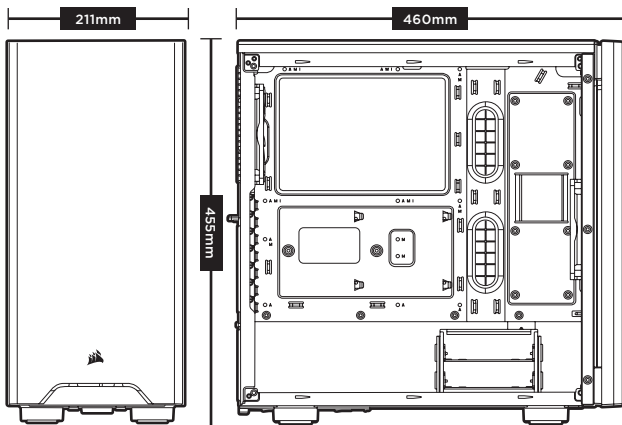

## СОДЕРЖИМОЕ КОМПЛЕКТА АКСЕССУАРОВ

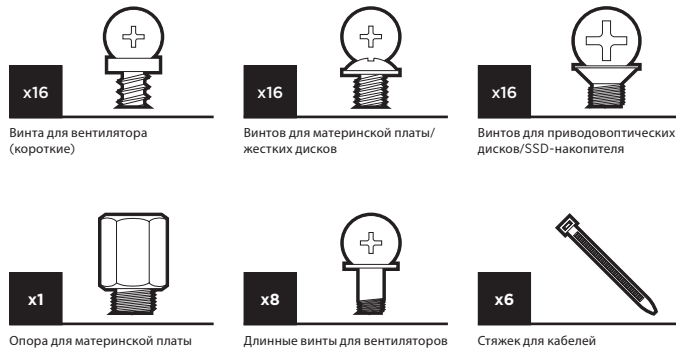

## ОСОБЕННОСТИ КОРПУСА

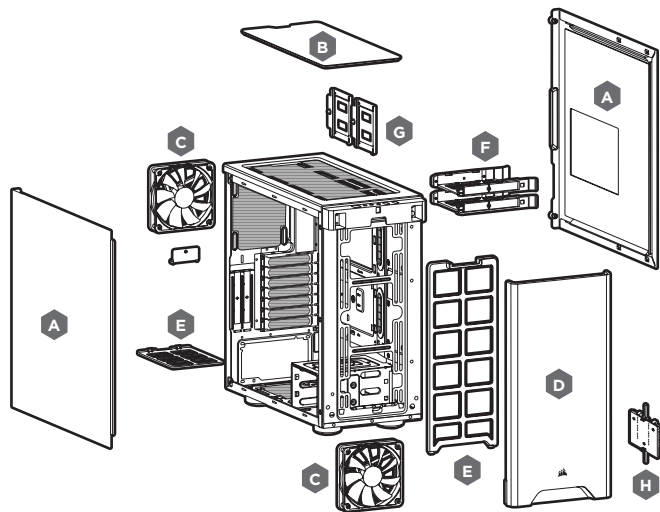

A — ПРОЧНАЯ БОКОВАЯ ПАНЕЛЬ С  
ИСПОЛЬЗОВАНИЕМ ШУМОПОДАВЛЯЮЩЕГО  
МАТЕРИАЛА

B — ПРОЧНАЯ ВЕРХНЯЯ ПАНЕЛЬ С  
ИСПОЛЬЗОВАНИЕМ ШУМОПОДАВЛЯЮЩЕГО  
МАТЕРИАЛА

C — 2x 120-МИЛЛИМЕТРОВЫЙ ВЕНТИЛЯТОР

D — ПЕРЕДНИЙ ОБОДОК

E — ПЫЛЕВОЙ ФИЛЬТР

F — ОТСЕК И ЛОТКИ ДЛЯ ЖЕСТКИХ ДИСКОВ

G — СЪЕМНЫЕ ОТСЕКИ ДЛЯ ТВЕРДОТЕЛЬНЫХ  
НАКОПИТЕЛЕЙ

H — ПОВТОРИТЕЛЬ ШИМ-СИГНАЛА ВЕНТИЛЯТОРА

## СНЯТИЕ БОКОВЫХ ПАНЕЛЕЙ

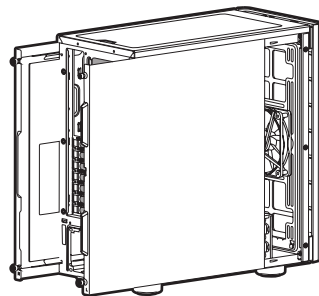

## УСТАНОВКА МАТЕРИНСКОЙ ПЛАТЫ

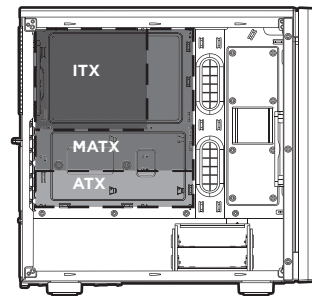



## УСТАНОВКА ЖЕСТКИХ ДИСКОВ

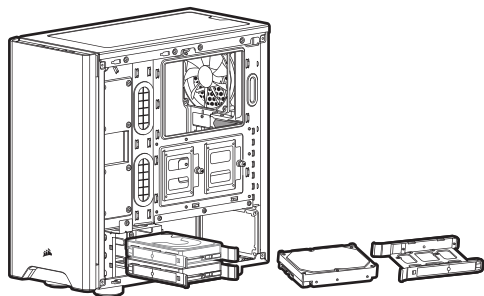

## УСТАНОВКА ТВОРДОТЕЛЬНЫХ НАКОПИТЕЛЕЙ

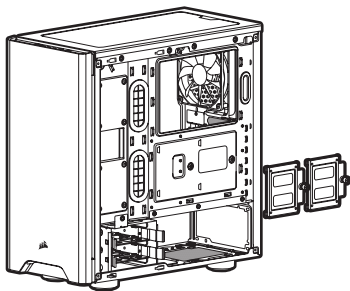

## УСТАНОВКА БЛОКА ПИТАНИЯ

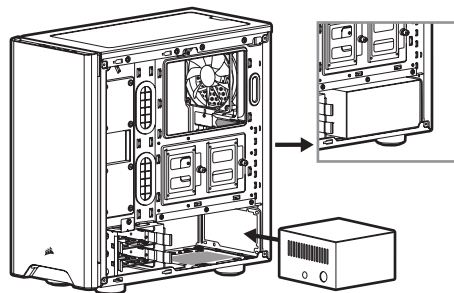

## УСТАНОВКА ПЛАТ PCI-e

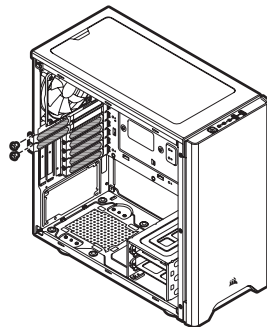

## СНЯТИЕ ПЕРЕДНЕГО ОБОДКА

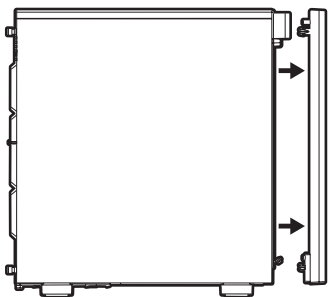

## УСТАНОВКА ПЕРЕДНИХ РАЗЪЕМОВ ВВОДА-ВЫВОДА

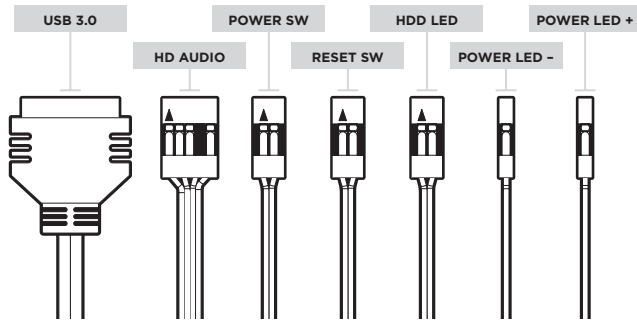

## ПОВТОРИТЕЛЬ ШИМ-СИГНАЛА ВЕНТИЛЯТОРА

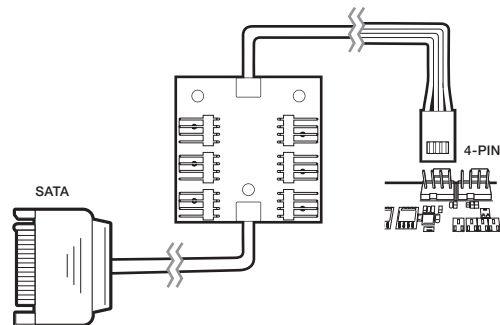

## ЧАСТО ЗАДАВАЕМЫЕ ВОПРОСЫ

- Имеет ли значение полярность при использовании разъема питания и сброса панели ввода-вывода?  
Нет, она важна только для светодиодных разъемов.
- К кому следует обратиться, если корпус получен поврежденным или один из вентиляторов не работает?  
Перейдите на веб-сайт [support.corsair.com](http://support.corsair.com) и запросите разрешение на возврат материалов (RMA), чтобы мы смогли заменить поврежденные детали.
- Где можно установить вентилятор?

Места установки вентиляторов	
Спереди	3x120mm / 2x140mm
Сверху	2x120mm / 1x140mm
Сзади	120mm

Дополнительную информацию об этом корпусе см. на странице продукта на веб-сайте [corsair.com](http://corsair.com).

## ESPECIFICAÇÕES DO GABINETE

Comprimento.....	460mm
Largura.....	211mm
Altura.....	455mm
Comprimento máximo da GPU.....	370mm
Altura máxima da CPU.....	170mm
Comprimento máximo da PSU.....	180mm

### Locais das ventoinhas:

Frente.....	3x120mm / 2x140mm
Topo.....	2x120mm / 1x140mm
Traseira.....	120mm

### Compatibilidade do radiador:

Frente.....	360mm / 280mm
Topo.....	240mm
Traseira.....	120mm

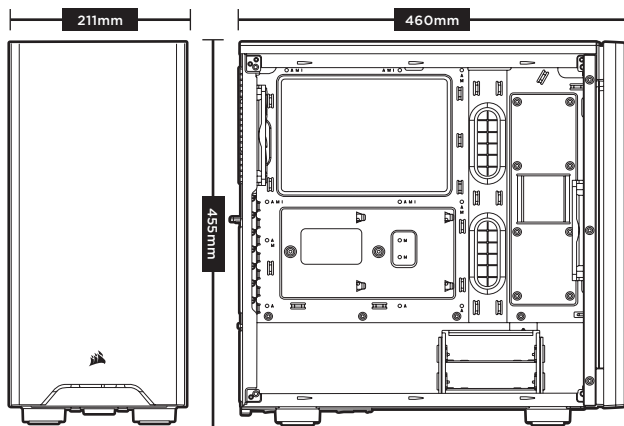

## CONTEÚDO DO KIT DE ACESSÓRIOS

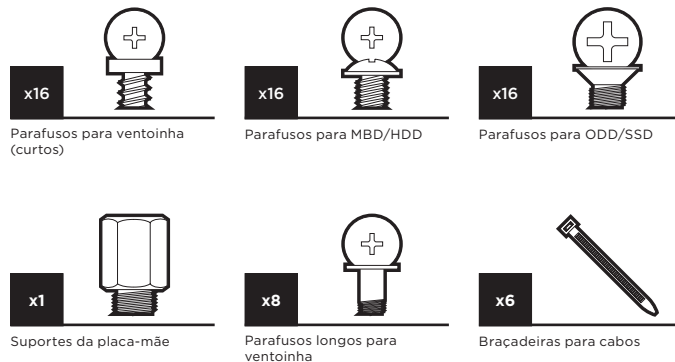

## RECURSOS DO GABINETE

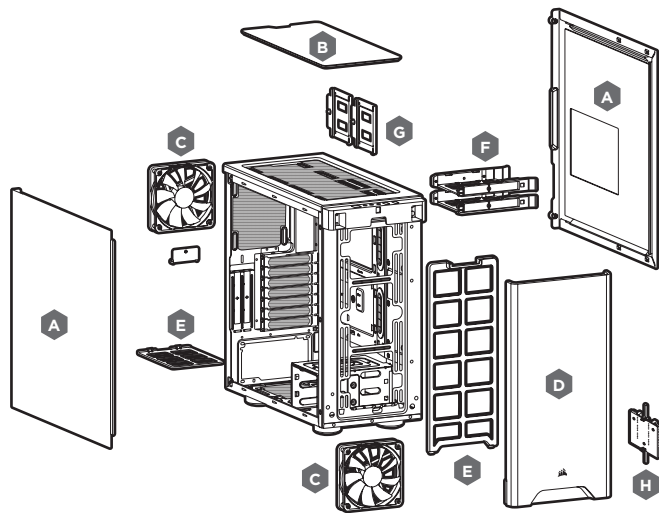

A – PAINEL LATERAL SÓLIDO COM MATERIAL PARA REDUÇÃO DE RUÍDO

B – PAINEL SUPERIOR SÓLIDO COM MATERIAL PARA REDUÇÃO DE RUÍDO

C – VENTONHA DE 2x 120mm

D – BISEL DIANTEIRO

E – FILTRO DE POEIRA

F – BANDEJAS E COMPARTIMENTO PARA HDD

G – BANDEJAS DE SSD REMOVÍVEIS

H – REPETIDOR PWM DE VENTONHA

## REMOVER OS PAINÉIS LATERAIS

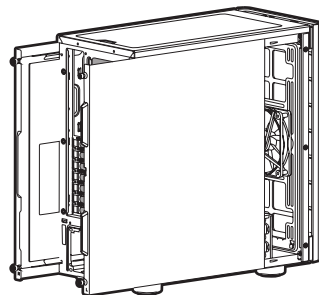

## INSTALAR A PLACA-MÃE

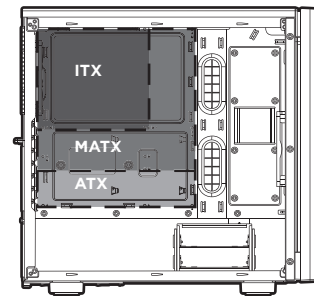

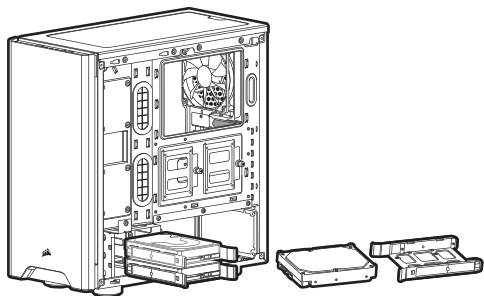
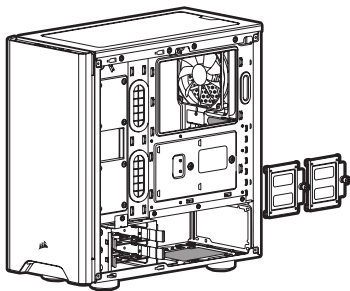
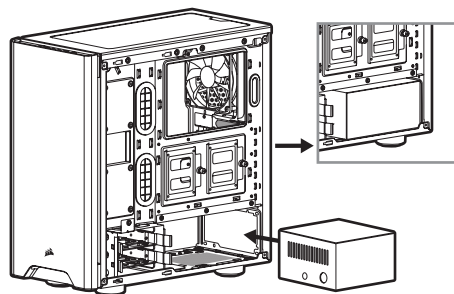
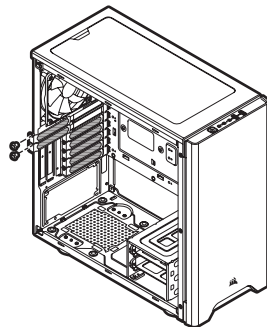
**INSTALAR HDDs****INSTALAR SSDs****INSTALAR A PSU****INSTALAR PLACAS PCI-e**

## REMOVER O BISEL DIAANTEIRO

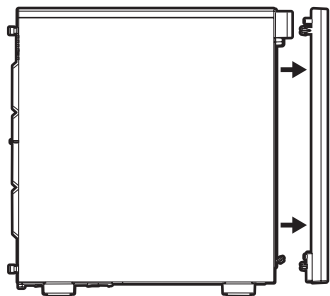

## INSTALAR OS CONECTORES DE E/S DIAANTEIROS

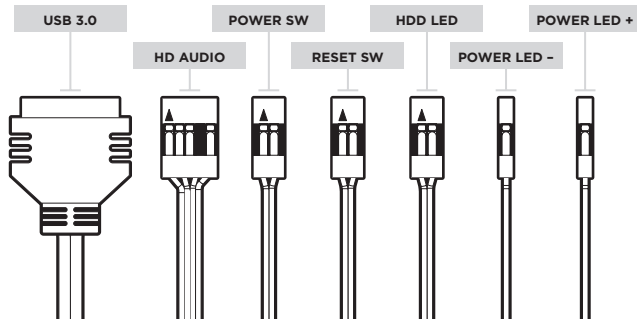

## REPETIDOR PWM DE VENTOINHA

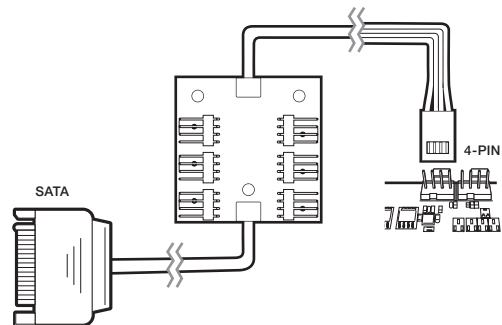

## PERGUNTAS FREQUENTES

1. ¿Hay que tener en cuenta la polaridad con la alimentación y el cabezal de restablecimiento del panel de E/S?  
No, solo los cabezales LED.
2. ¿Con quién debo ponerme en contacto si recibo mi chasis dañado o si uno de los ventiladores deja de funcionar?  
Vaya a [support.corsair.com](http://support.corsair.com) y solicite un RMA para que podamos reemplazar las piezas dañadas.
3. ¿Dónde puedo montar un ventilador?

Puntos de montaje del ventilador	
Parte delantera	3x120mm / 2x140mm
Parte superior	2x120mm / 1x140mm
Parte posterior	120mm

Para obtener más información sobre este chasis, visite la página del producto en [corsair.com](http://corsair.com).

**CAUTION!**

The manufacturer is not responsible for any radio or TV interference caused by unauthorized modifications to this equipment. Such modifications could void the user authority to operate the equipment.



This equipment has been tested and found to comply with the limits for a Class B digital device, pursuant to part 15 of the FCC Rules. These limits are designed to provide reasonable protection against harmful interference in a residential installation. This equipment generates, uses and can radiate radio frequency energy and, if not installed and used in accordance with the instructions, may cause harmful interference to radio communications. However, there is no guarantee that interference will not occur in a particular installation. If this equipment does cause harmful interference to radio or television reception, which can be determined by turning the equipment off and on, the user is encouraged to try to correct the interference by one or more of the following measures:

- > Reorient or relocate the receiving antenna.
- > Increase the separation between the equipment and receiver.
- > Connect the equipment into an outlet on a circuit different from that to which the receiver is connected.
- > Consult the dealer or an experienced radio/TV technician for help.

This device must not be co-located or operating in conjunction with any other antenna or transmitter.

Operation is subject to the following two conditions:

- (1) This device may not cause harmful interference, and
- (2) This device must accept any interference received, including interference that may cause undesired operation.



CORSAIR MEMORY, Inc. declares that this equipment is compliance with Directive 2011/65/EU. A copy of the original declaration of conformity can be obtained at "regulatory@corsair.com".

CORSAIR MEMORY, Inc. déclare que son équipement est conforme à la directive 2011/65/EU. Une copie de la déclaration de conformité originale peut être obtenue en envoyant un courrier électronique à l'adresse regulatory@corsair.com.

CORSAIR MEMORY, Inc. erklärt, dass dieses Gerät den Richtlinien 2011/65/EU entspricht. Eine Kopie der ursprünglichen Konformitätserklärung kann unter regulatory@corsair.com angefordert werden.

CORSAIR MEMORY, Inc. dichiara che questa apparecchiatura è conforme alla Direttiva 2011/65/EU. Una copia della dichiarazione originale di conformità è disponibile scrivendo un'email all'indirizzo "regulatory@corsair.com".

CORSAIR MEMORY, Inc. declara que este equipo cumple con la directiva 2011/65/EU. Puede obtener una copia de la declaración de conformidad original en "regulatory@corsair.com".

CORSAIR MEMORY, Inc. declara que este equipamento está em conformidade com a Norma 2011/65/EU. É possível obter uma cópia da declaração original de conformidade pelo e-mail "regulatory@corsair.com".

THE AUTHORIZED REPRESENTATIVE IN EUROPE  
CORSAIR MEMORY, BV  
Wormerweg 8, 1311 XB, Almere, Netherlands

LE REPRESENTANT AGRÉÉ EN EUROPE  
CORSAIR MEMORY, BV  
Wormerweg 8, 1311 XB, Almere, Netherlands

DIE AUTORISIERTEN VERTRETER IN EUROPA  
CORSAIR MEMORY, BV  
Wormerweg 8, 1311 XB, Almere, Netherlands

IL RAPPRESENTANTE AUTORIZZATO PER L'EUROPA  
CORSAIR MEMORY, BV  
Wormerweg 8, 1311 XB, Almere, Netherlands

EL REPRESENTANTE AUTORIZADO EN EUROPA  
CORSAIR MEMORY, BV  
Wormerweg 8, 1311 XB, Almere, Netherlands

O REPRESENTANTE AUTORIZADO NA EUROPA  
CORSAIR MEMORY, BV  
Wormerweg 8, 1311 XB, Almere, Netherlands

**Note on environmental protection**

After the implementation of the European Directive 2012/19/EU in the national legal system, the following applies:

- > Electrical and electronic devices may not be disposed of with domestic waste.
- > Consumers are obligated by law to return electrical and electronic devices at the end of their service lives to the public collecting points set up for this purpose of point of sale. Details to this are defined by the national law of the respective country. This symbol on the product, the instruction manual or the package indicates that a product is subject to these regulations. By recycling, reusing the materials or other forms of utilizing old devices, you are making an important contribution to protecting our environment.

**Remarques concernant la protection de l'environnement**

Conformément à la directive européenne 2012/19/EU, et afin d'atteindre un certain nombre d'objectifs en matière de protection de l'environnement, les règles suivantes doivent être appliquées:

- > Elles concernent les déchets d'équipement électriques et électroniques. Le pictogramme "picto" présent sur le produit, son manuel d'utilisation ou son emballage indique que le produit est soumis à cette réglementation.
- > Le consommateur doit retourner le produit usager aux points de collecte prévus à cet effet. Il peut aussi le remettre à un revendeur. En permettant enfin le recyclage des produits, le consommateur contribuera à la protection de notre environnement. C'est un acte écologique.

**Hinweis zum Umweltschutz**

Ab dem Zeitpunkt der Umsetzung der europäischen Richtlinie 2012/19/EU in nationales Recht gilt folgendes:

- > Elektrische und elektronische Geräte dürfen nicht mit dem Hausmüll entsorgt werden.
- > Der Verbraucher ist gesetzlich verpflichtet, elektrische und elektronische Geräte am Ende ihrer Lebensdauer an den dafür eingerichteten, öffentlichen Sammelstellen oder an die Verkaufsstelle zurückzugeben. Einzelheiten dazu regelt das jeweilige Landesrecht. Das Symbol auf dem Produkt, der Gebrauchsanleitung oder der Verpackung weist auf diese Bestimmungen hin. Mit der Wiederverwertung, der stofflichen Verwertung oder anderer Formen der Verwertung von Altgeräten leisten Sie einen wichtigen Beitrag zum Schutz unserer Umwelt. In Deutschland gelten oben genannte Entsorgungsregeln, laut Batterieverordnung, für Batterien und Akkus entsprechend.

**Informazioni per protezione ambientale**

Dopo l'implementazione della Direttiva Europea 2012/19/EU nel sistema legale nazionale, ci sono le seguenti applicazioni:

- > I dispositivi elettrici ed elettronici non devono essere considerati rifiuti domestici.

> I consumatori sono obbligati dalla legge a restituire i dispositivi elettrici ed elettronici alla fine della loro vita utile ai punti di raccolta pubblici preposti per questo scopo e nei punti vendita. Dettagli di quanto riportato sono definiti dalle leggi nazionali di ogni stato. Questo simbolo sul prodotto, sul manuale d'istruzioni o sull'imballo indicano che questo prodotto è soggetto a queste regole.

**Nota sobre la protección medioambiental**

Después de la puesta en marcha de la directiva Europea 2012/19/EU en el sistema legislativo nacional, se aplicará lo siguiente:

- > Los aparatos eléctricos y electrónicos, así como las pilas y las pilas recargables, no se deben evacuar en la basura doméstica.
- > El usuario está legalmente obligado a llevar los aparatos eléctricos y electrónicos, así como pilas y pilas recargables, al final de su vida útil a los puntos de recogida comunales o a devolverlos al lugar donde los adquirió. Los detalles quedaran definidos por la ley de cada país. El símbolo en el producto, en las instrucciones de uso o en el embalaje hace referencia a ello. Gracias al reciclaje, al reciclaje del material o a otras formas de reciclaje de aparatos usados, contribuye Usted de forma importante a la protección de nuestro medio ambiente.

**Nota em Protecção Ambiental**

Após a implementação da directiva comunitária 2012/19/EU no sistema legal nacional, o seguinte aplica-se:

- > Todos os aparelhos eléctricos e electrónicos não podem ser despejados juntamente com o lixo doméstico.
- > Consumidores estão obrigados por lei a colocar os aparelhos eléctricos e electrónicos sem uso em locais públicos específicos para este efeito ou no ponto de venda. Os detalhes para este processo são definidos por lei pelos respectivos países. Este símbolo no produto, o manual de instruções ou a embalagem indicam que o produto está sujeito a estes regulamentos. Reciclando, reutilizando os materiais dos seus velhos aparelhos, está a fazer uma enorme contribuição para a protecção do ambiente.



### Notitie aangaande de bescherming van het milieu

Ten gevolge van de invoering van de Europese Richtlijn 2012/19/EU in het nationaal juridisch systeem, is het volgende van toepassing:

- > Elektrische en elektronische toestellen mogen niet weggegooid worden tezamen met het huishoudelijk afval.
- > Consumenten zijn wettelijk verplicht om elektrische en elektronische apparaten op het einde van gebruik in te dienen bij openbare verzamelplaatsen speciaal opgezet voor dit doeleinde of bij een verkooppunt. Verdere specificaties aangaande dit onderwerp zijn omschreven door de nationale wet van het betreffende land. Dit symbool op het product, de gebruiksaanwijzing of de verpakking duidt erop dat het product onderworpen is aan deze richtlijnen. Door te recyclen, hergebruiken van materialen of andere vormen van hergebruiken van oude toestellen, levert u een grote bijdrage aan de bescherming van het milieu.

### Not om miljöskydd

Efter implementeringen av EU direktiv 2012/19/EU i den nationella lagstiftningen, gäller följande:

- > Elektriska och elektroniska apparater får inte avyttras med hushållsaffall.
- > Konsumenter är skyldiga att återlämna elektriska och elektroniska apparater vid slutet av dess livslängd till, för detta ändamål, offentliga uppsamlingsplatser. Detaljer för detta definieras via den nationella lagstiftningen i respektive land. Denna symbol på produkten, instruktionsmanualen eller på förpackningen indikerar att produkten innefattas av denna bestämmelse. Genom återvinning och återanvändning av material bidrar du till att skydda miljön och din omgivning.

### Ympäristönsojeluksa koskeva ohje

Siitä lähtien, kun Euroopan unionin direktiivi 2012/19/EU otetaan käyttöön kansallisessa lainsäädännössä, päteväät seuraavat määräykset:

- > Sähkö- ja elektroniikkalaitteita ei saa hävittää talousjätteen mukana.
- > Kuluttajilla on lain mukaan velvollisuus toimittaa sähkö- ja elektroniikkalaitteet niiden käyttöön päätyttyä niille varattuihin julkisiin keräyspisteisiin tai palauttaa ne myyntipaikkaan. Tähän liittyvästä yksityiskohdistista säädetään kulloisenkin osavaltion laissa. Näistä määräyksistä mainitaan myös tuotteen symbolissa, käyttöohjeissa tai pakkaussessa. Uudelleenkytöillä, materiaalien uudelleenkytöillä tai muilla vanhojen laitteiden uudelleenkäyttövoilla on tärkeä vaikutus yhteisen ympäristömme suojelelta.

### Wskazówki dotyczące ochrony środowiska

Od czasu wprowadzenia europejskiej dyrektywy 2012/19/EU do prawa narodowego obowiązują następujące ustalenia:

- > Urządzeni elektrycznych i elektronicznych nie należy wyrzucać wraz z innymi odpadami domowymi.
- > Użytkownik zobowiązuje się, nieporządnie lub zniszczone urządzenia elektryczne odebrać do punktu zbiórki lub do sprzedawcy. Szczegółowe kwestie regulują przepisy prawne danego kraju. Informuje o tym symbol przekreślonego kosza umieszczonego na opakowaniu. Segregując śmieci pomagasz chronić środowisko naturalne.

### Ochrana životního prostředí

Evropská směrnice 2012/19/EU stanovuje:

- > Elektrické a elektronické přístroje se nesmí vzhazovat do domácího odpadu.
- > Elektrické a elektronické přístroje musí být zlikvidovány podle zákona na smetech k tomu určených. Recyklaci nebo jiným způsobem zpracování výrazně přispíváte k ochraně našeho životního prostředí!

### Környezetvédelmi tudnivalók

- > Európai irányelvnek 2012/19/EU ajánlása szerint, a megjelölt időponttól kezdve, minden EU-s tagállamban érvényesek a következők:
- > A leselejtezett elektromos és elektronikus készülékek nem szabad a háztartási szeméttel dobni.
- > Az elhasznált és мүködésképtelen elektrikus és elektronikus készülékek gyűjtésére törvényi előírás kötelez mindenkit, ezért azokat el kell szállítani egy kijelölt gyűjtő helyre vagy visszavinni a vásárlás helyére. A termék csomagolásán feltüntetett szimbólum egyértelmű jelzést ad erre vonatkozóan a felhasználónak. A régi készülékek begyűjtése, visszaváltsa vagy bármilyen formában történő újra hasznosítása közös hozzájárulás környezetünk védelméhez.

### Ochrana životného prostredia

Európska smernica 2012/19/EU stanovuje:

- > Elektrické a elektronické zariadenia sa nesmú vyhazovať do domáceho odpadu.
- > Spotrebiteľ je zo zákona povinný zlikvidovať elektrické a elektronické zariadenia na miesta k tomu určené. Symbolizuje to obrázok v nádve na pouzítie, alebo na balení výrobku. Recykláciou, alebo inými formami využitia starých prístrojov prispievate v značnej miere k ochrane nášho životného prostredia.



### Çevre koruma uyarısı

Avrupa Birliği Direktifi 2012/19/EU ulusal yasal uygulamalar için de geçerli olduđu tarhten itibaren:

- > Elektrikli ve elektronik cihazlar normal evsel çöpe atılmamalıdır.
- > Tüketiciler için, artık çalışmayan elektrikli ve elektronik cihazları, kamuya ait toplama yerlerine götürme veya satın alınıkları yerlere geri verme yasal bir zorunluluktur. Bu konu ile ilgili ayrıntılı ulusal yasaların düzenlemektir. Ürün üzerindeki kulluğuna kilavuzunda veya ambalajda bulunan bir sembol tüketimciyi bu konuda uyarır. Eski cihazların geri kazanımı, yapıldıkları malzemelerin değerlendirilmesi veya diğer değerlendirme şekilleri ile, çevre korumasına önemli bir katkıda bulunursunuz. Yukarıda adı geçen atık toplama kuralları Almanya'da piller ve aküler için de geçerlidir.

### Anvisninger til beskyttelse af miljøet

Efter implementeringen af det europæiske direktiv 2012/19/EU i det nationale lovgivningssystem gælder følgende:

- > Elektriske og elektroniske apparater må ikke bortskaffes med husholdningsaffald.
- > Forbrugeren er ved afslutningen af elektriske og elektroniske apparaters levetid lovmæssigt forpligtet til at aflevere disse på de dertil indrettede offentlige indsamlingssteder eller hos sælgeren. Enkeltheder vedrørende dette fastlægges af de respektive landes nationale lovgivning. Dette symbol på produktet, betjeningsvejledningen eller emballagen viser, at produktet er underlagt disse bestemmelser. Med genanvendelse, genanvendelse af materialer eller andre former for genbrug af gamle apparater yder du et vigtigt bidrag til beskyttelse af vores miljø.

### Informasjon om beskyttelse av miljøet

Efter implementering av EU-direktiv 2012/19/EU i det nasjonale lovverk, er følgende gjort gjeldende:

- > Elektrisk og elektronisk utstyr skal ikke kastes sammen med husholdningsavfall.
- > Forbrukere er pålagt ved lov å returnere elektrisk og elektronisk utstyr ved enden av levetiden til offentlige oppsamlingspunkter, oppsett for dette formål eller til utsalgssteder for slikt utstyr. Detaljer rundt dette er definert i lovverket i det respektive land. Dette symbolet på produktet, bruksanvisningen eller forpakningen forteller at et produkt faller inn under disse betingelsene. Ved resirkulering, genbruk av materiale eller på andre måter å nyttiggjøre gammelt utstyr bidrar du på en viktig måte til å beskytte vårt felles miljø!

### Υπόδειξη σχετικά με την προστασία περιβάλλοντος

Από τη στιγμή που η Ευρωπαϊκή Οδηγία 2012/19/EU ενσωματώνεται στο εθνικό δικαίο ισχύουν τα εξής:

- > Οι ηλεκτρικές και ηλεκτρονικές συσκευές δεν επιτρέπεται να πετούνται στα σκουπίδια.
- > Ο καταναλωτής υποχρεούται διά νόμου να επιστρέψει τις ηλεκτρικές και ηλεκτρονικές συσκευές στο τέλος της ζωής τους στα τα ειδικά προβλεπόμενα σημεία συλλογής ή στα καταστήματα αγοράς. Οι λεπτομέρειες ρυθίζονται στη σχετική νομοθεσία. Το σύμβολο πάνω στο προϊόν, στο εγχειρίδιο χρήσης ή τη συσκευασία παραπέμπει σε αυτές τις διατάξεις. Με την επαναχρησιμοποίηση, την ανακύκλωση των υλικών ή με άλλους τρόπους αξιοποίησης των παλαιών συσκευών συμμετέχετε ενεργά στην προστασία του περιβάλλοντος μας. Στη Γερμανία ισχύουν αντίστοιχα οι παραπάνω κανόνες απόρριψης σύμφωνα με τον κανονισμό για μπαταρίες και συσσωρευτές.

### Охрана окружающей среды

- С момента перехода национального законодательства на европейские нормы 2012/19/EU действительно следующие:
- > Электронические и электронные приборы запрещается утилизировать вместе с обычным мусором.
- > Потребитель, согласно закону, обязан утилизировать электронные и электронные приборы в специально предназначенных для этого пунктах сбора, либо пункта продажи. Детальная регламентация этих требований осуществляется соответствующим местным законодательством. Необходимость соблюдения данных предписаний обозначается особым знаком на изделии, инструкции по эксплуатации или упаковке. При переработке, повторном использовании материалов или при другой форме утилизации бывших в употреблении приборов особое внимание уделяйте охране окружающей среды. В соответствии с предписаниями по обращению с батареями, в Германии вышеназванные нормы действуют для утилизации батареек и аккумуляторов.