



CORSAIR

iCUE

H100i | H150i | H170i

ELITE LCD XT

EXTREME PERFORMANCE LCD LIQUID CPU COOLER

EN ENGLISH

IT ITALIANO

SC 简体中文

FR FRANÇAIS

ES ESPAÑOL

AR العربية

DE DEUTSCH

PT PORTUGUÊS

NL NEDERLANDS

PL POLSKI



Note: Most newer PC cases include a CPU cut-out to allow access to the bottom of the motherboard. If your case does not include a cut-out, you will need to remove your motherboard from the case prior to installation. ELITE LCD XT coolers come with the Intel mounting bracket pre-installed on the pump for quick installation.

TABLE OF CONTENTS

INTEL (All Sockets)

AMD AM5/AM4

AMD sTRX4

INSTALLATION



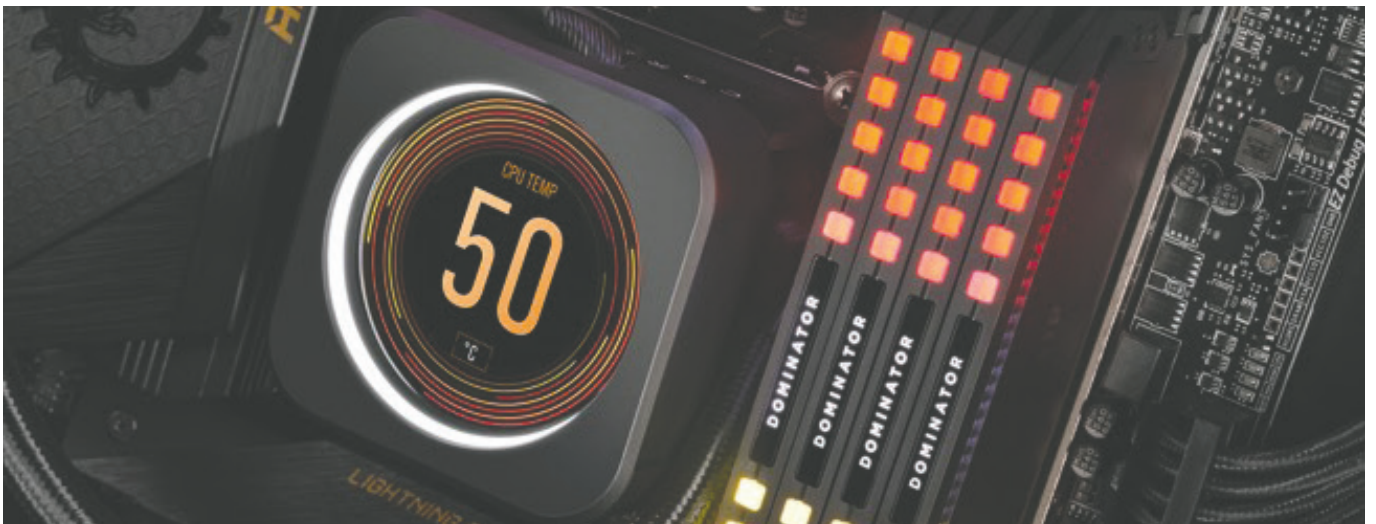







FAQ

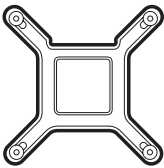
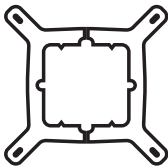
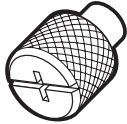

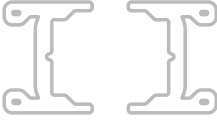
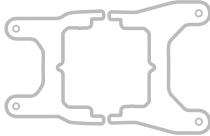
Please ensure you power down your entire PC before installation. The LCD module, the pump, and the COMMANDER CORE are sensitive to hotplugging and ESD.

INCLUDED HARDWARE

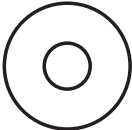
Highlighted parts for Intel installation only

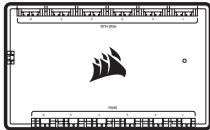
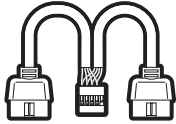
<p>A</p>  <p>x4 INTEL 1200/1150/1151/1156/1155 STANDOFFS</p>	<p>B</p>  <p>x4 INTEL 2011/2011-3/2066 STANDOFFS</p>	<p>C</p>  <p>x4 INTEL 1700 STANDOFFS</p>
<p>D</p>  <p>x1 INTEL BACKPLATE</p>	<p>E</p>  <p>x1 INTEL MOUNTING BRACKET (PRE-INSTALLED)</p>	<p>F</p>  <p>x4 THUMBSCREWS</p>
<p>G</p>  <p>x4 AMD AM5/AM4 STANDOFFS</p>	<p>H</p>  <p>x1 AMD AM5/AM4 MOUNTING BRACKET</p>	<p>I</p>  <p>x1 AMD sTR4/sTRX4 MOUNTING BRACKET</p>
<p>J</p>  <p>x4 AMD sTR4/sTRX4 STANDOFFS</p>	<p>K</p>  <p>x16 LONG FAN SCREWS (H100i) x24 LONG FAN SCREWS (H150i/H170i)</p>	<p>L</p>  <p>x8 RADIATOR SCREWS (H100i) x12 RADIATOR SCREWS (H150i/H170i)</p>
<p>M</p>  <p>x8 WASHERS (H100i) x12 WASHERS (H150i/H170i)</p>	<p>N</p>  <p>x2 AF RGB ELITE FANS (H100i) x3 AF RGB ELITE FANS (H150i/H170i)</p>	<p>O</p>  <p>COMMANDER CORE</p>
<p>P</p>  <p>USB Y-SPLITTER</p>		

1. INSTALLING THE INTEL BACKPLATE

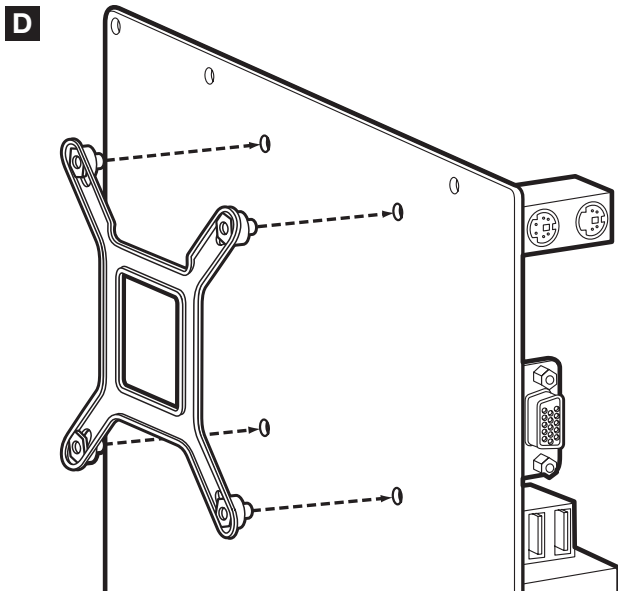

Adjust backplate for your required socket.

Note: Intel LGA 2011/2011-3/2066 do not require backplate installation. Proceed to step 2.

2. INSTALLING THE INTEL STANDOFF SCREWS

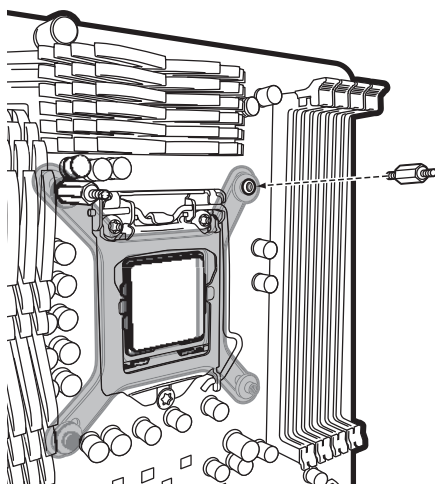

A LGA 1200/1150/
1151/1155/1156

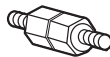

B LGA 2011/
2011-3/2066

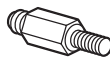

C LGA 1700

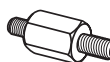

- > Attach the provided Intel standoff for your socket.
- > Use (A) for LGA 1200/115X, (B) for LGA 2011/2011-3/2066 or (C) for LGA 1700.
- > Tighten all four screws until firmly secured.

3. INSTALL THE FANS AND RADIATOR

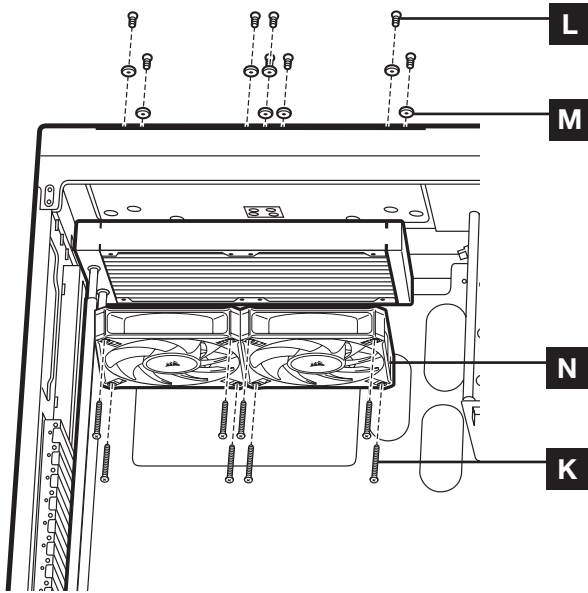

Attach the radiator and the fans as shown. For the best cooling performance, we recommend mounting the fans as an air-intake to your PC case.

4. INSTALLING THE PUMP UNIT

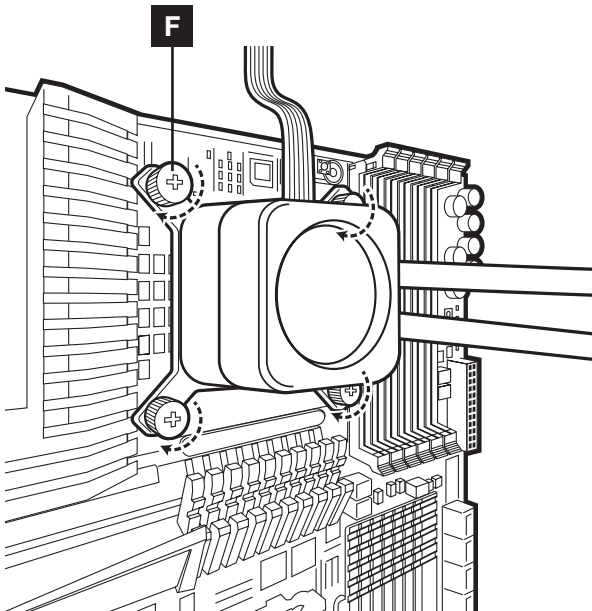









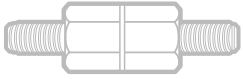

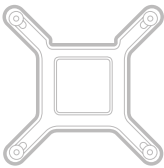
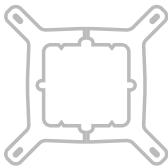
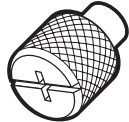
- > Align the bracket and pump over the standoff screws as shown.
- > Attach the thumbscrews (F) to the standoff screws as shown.
- > Tighten the thumbscrews until all four corners are firmly secured.

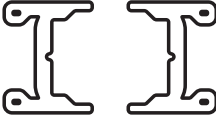
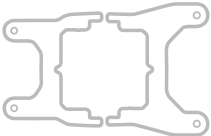
Please continue to Page 10 to continue your installation.

INCLUDED HARDWARE

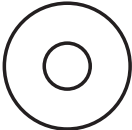
Highlighted parts for AMD AM5/AM4 installation only

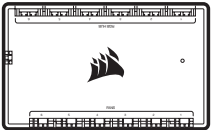
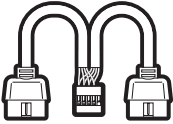
<p>A</p>  <p>x4 INTEL 1200/1150/1151/1156/1155 STANDOFFS</p>	<p>B</p>  <p>x4 INTEL 2011/2011-3/2066 STANDOFFS</p>	<p>C</p>  <p>x4 INTEL 1700 STANDOFFS</p>
<p>D</p>  <p>x1 INTEL BACKPLATE</p>	<p>E</p>  <p>x1 INTEL MOUNTING BRACKET (PRE-INSTALLED)</p>	<p>F</p>  <p>x4 THUMBSCREWS</p>
<p>G</p>  <p>x4 AMD AM5/AM4 STANDOFFS</p>	<p>H</p>  <p>x1 AMD AM5/AM4 MOUNTING BRACKET</p>	<p>I</p>  <p>x1 AMD sTR4/sTRX4 MOUNTING BRACKET</p>
<p>J</p>  <p>x4 AMD sTR4/sTRX4 STANDOFFS</p>	<p>K</p>  <p>x16 LONG FAN SCREWS (H100i) x24 LONG FAN SCREWS (H150i/H170i)</p>	<p>L</p>  <p>x8 RADIATOR SCREWS (H100i) x12 RADIATOR SCREWS (H150i/H170i)</p>
<p>M</p>  <p>x8 WASHERS (H100i) x12 WASHERS (H150i/H170i)</p>	<p>N</p>  <p>x2 AF RGB ELITE FANS (H100i) x3 AF RGB ELITE FANS (H150i/H170i)</p>	<p>O</p>  <p>COMMANDER CORE</p>
<p>P</p>  <p>USB Y-SPLITTER</p>		

1. INSTALLING THE AMD AM5/AM4 MOUNTING BRACKET

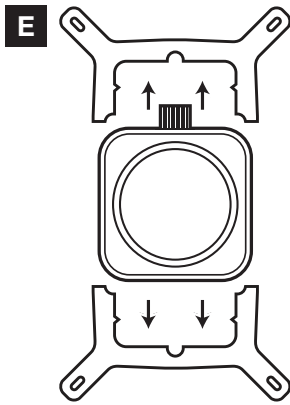

Figure 1

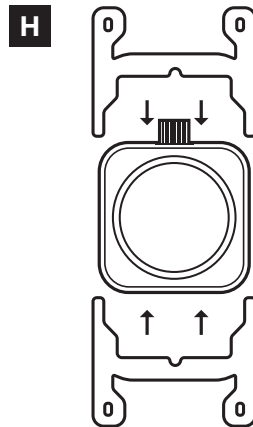
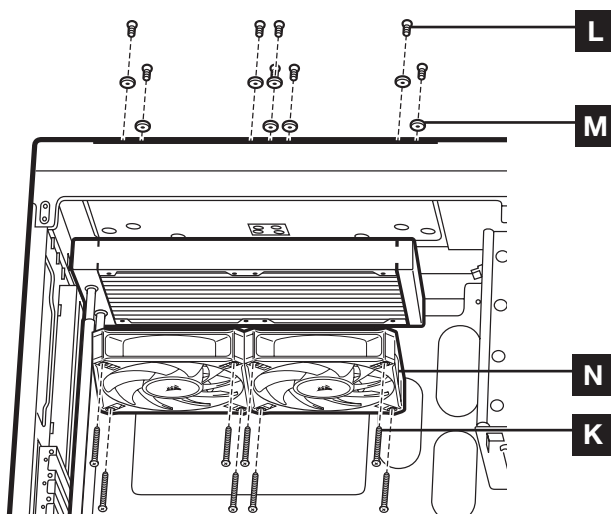

Figure 2

- > Remove the integrated Intel mounting bracket (Figure 1).
- > Install the AMD AM5/AM4 bracket by pushing both sides into the slot on the pump until secure (Figure 2).

Note: It is important that the AMD AM5/AM4 retention bracket be evenly secured on all sides before installation.

2. INSTALL THE FANS AND RADIATOR



Attach the radiator and the fans as shown. For the best cooling performance, we recommend mounting the fans as an air-intake to your PC case.

3. PREPARE THE MOTHERBOARD FOR INSTALLATION

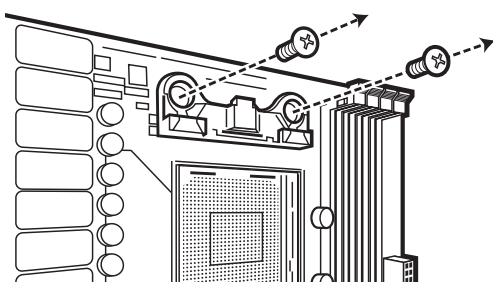

Remove the existing AMD AM5/AM4 mounting brackets shown.

4. INSTALLING THE AMD AM5/AM4 STANDOFF SCREWS

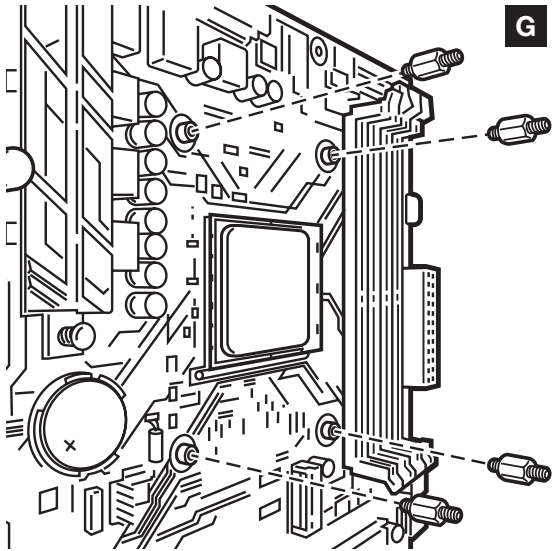

- > Attach the provided AMD AM5/AM4 standoffs to the CPU socket.
- > Tighten all four screws until firmly secure.

5. INSTALLING THE PUMP UNIT

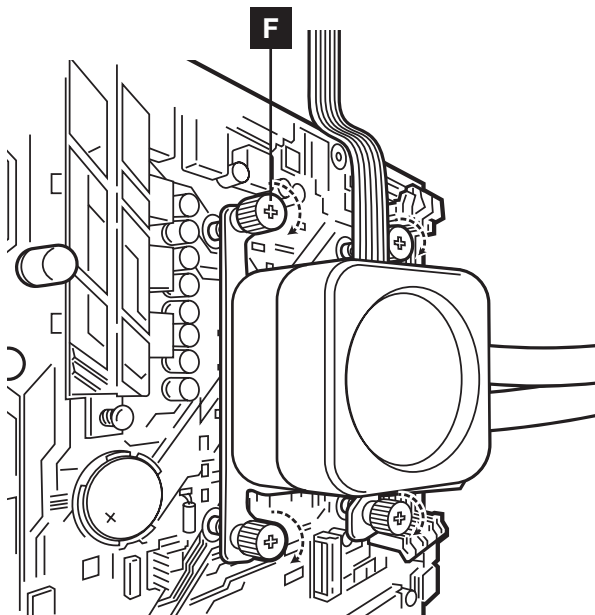







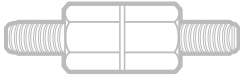

Align the bracket with the AMD AM5/AM4 standoffs as shown. Tighten the thumbscrews (F) until secure.

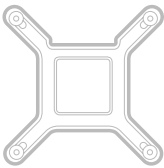
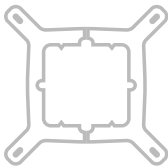
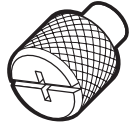
Please continue to Page 10 to continue your installation.

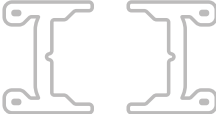
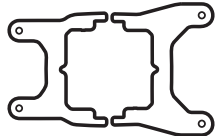
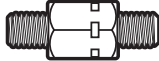
INCLUDED HARDWARE

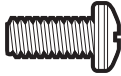
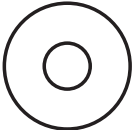
Highlighted parts for AMD sTRX4 installation only

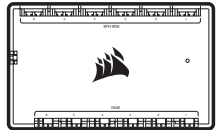
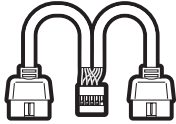
<p>A</p>  <p>x4 INTEL 1200/1150/1151/1156/1155 STANDOFFS</p>	<p>B</p>  <p>x4 INTEL 2011/2011-3/2066 STANDOFFS</p>	<p>C</p>  <p>x4 INTEL 1700 STANDOFFS</p>
<p>D</p>  <p>x1 INTEL BACKPLATE</p>	<p>E</p>  <p>x1 INTEL MOUNTING BRACKET (PRE-INSTALLED)</p>	<p>F</p>  <p>x4 THUMBSCREWS</p>
<p>G</p>  <p>x4 AMD AM5/AM4 STANDOFFS</p>	<p>H</p>  <p>x1 AMD AM5/AM4 MOUNTING BRACKET</p>	<p>I</p>  <p>x1 AMD sTR4/sTRX4 MOUNTING BRACKET</p>
<p>J</p>  <p>x4 AMD sTR4/sTRX4 STANDOFFS</p>	<p>K</p>  <p>x16 LONG FAN SCREWS (H100i) x24 LONG FAN SCREWS (H150i/H170i)</p>	<p>L</p>  <p>x8 RADIATOR SCREWS (H100i) x12 RADIATOR SCREWS (H150i/H170i)</p>
<p>M</p>  <p>x8 WASHERS (H100i) x12 WASHERS (H150i/H170i)</p>	<p>N</p>  <p>x2 AF RGB ELITE FANS (H100i) x3 AF RGB ELITE FANS (H150i/H170i)</p>	<p>O</p>  <p>COMMANDER CORE</p>
<p>P</p>  <p>USB Y-SPLITTER</p>		

1. INSTALLING THE AMD sTRX4 MOUNTING BRACKET

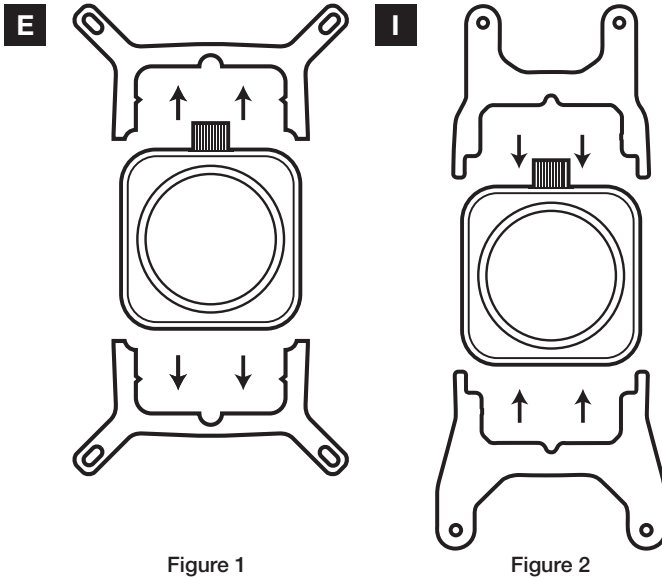

- > Remove the integrated Intel mounting bracket (Figure 1).
- > Install the AMD sTRX4 bracket by pushing both sides into the slot on the pump until secure (Figure 2).

Note: It is important that the AMD sTRX4 retention bracket be evenly secured on all sides before installation.

2. INSTALLING THE AMD sTRX4 STANDOFF SCREWS

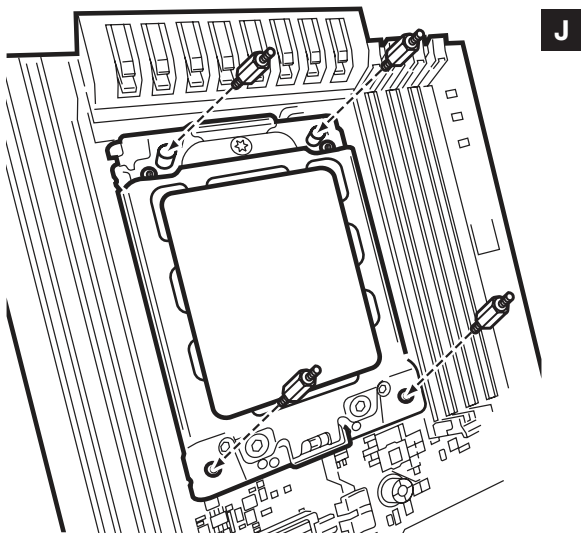

- > Attach the provided AMD sTRX4 standoffs to the CPU socket.
- > Tighten all four screws until firmly secure.

3. INSTALL THE FANS AND RADIATOR

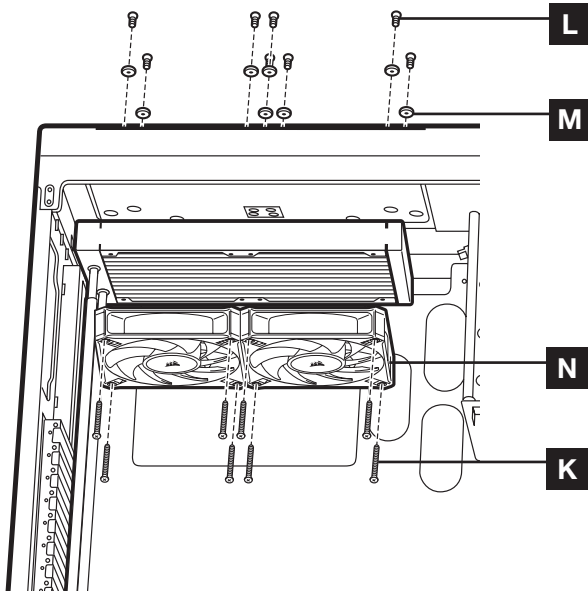

Attach the radiator and the fans as shown. For the best cooling performance, we recommend mounting the fans as an air-intake to your PC case.

4. INSTALLING THE PUMP UNIT

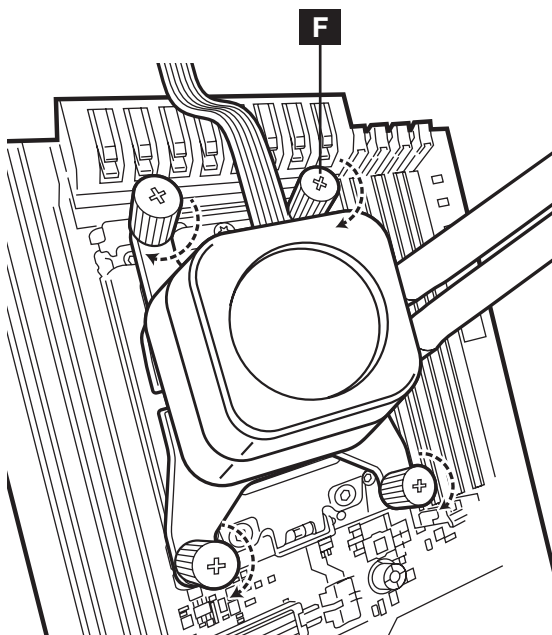

- > Align the bracket and pump over the standoff screws as shown.
- > Attach the thumbscrews (F) to the standoff screws as shown.
- > Tighten the thumbscrews until all four corners are firmly secured.

Please continue to Page 10 to continue your installation.

CONNECT FANS AND PUMP TO COMMANDER CORE

- > Connect pump 24-pin cable to your COMMANDER CORE (Figure 1).
- > Connect pump tach cable to the CPU_FAN header on your motherboard (Figure 2).
- > Connect each fan to the COMMANDER CORE (Figure 3).
- > Connect each fan RGB lead to the COMMANDER CORE (Figure 3).

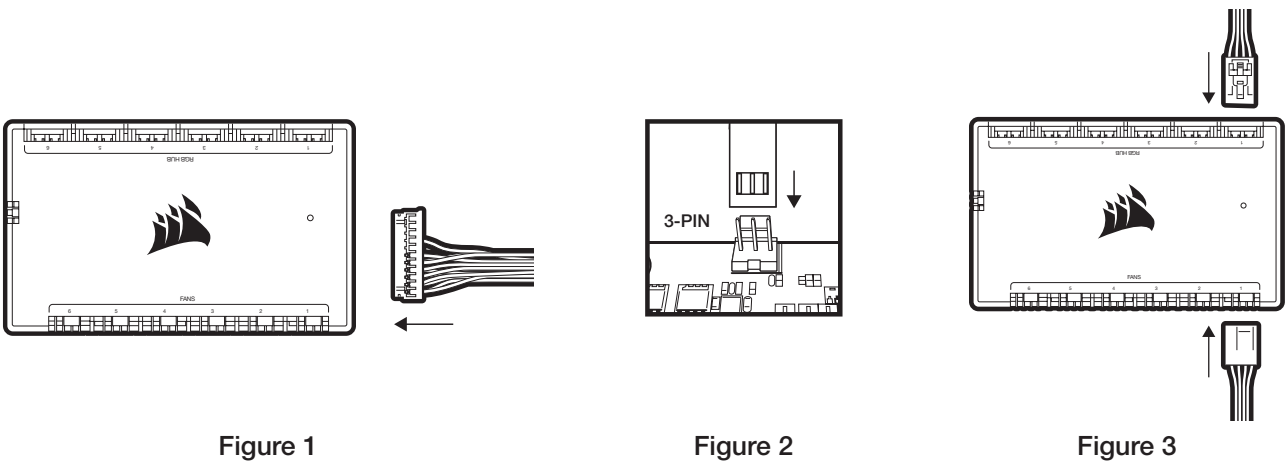

CONNECT COMMANDER CORE AND ELITE LCD XT MODULE TO USB 2.0 HEADER AND POWER

- > Using the attached USB cable, connect the COMMANDER CORE to a motherboard USB 2.0 header.
- > Connect pump power cable to an available SATA power plug from your power supply.
- > Use included USB Y-Splitter to reduce required USB ports from 2x to 1x.

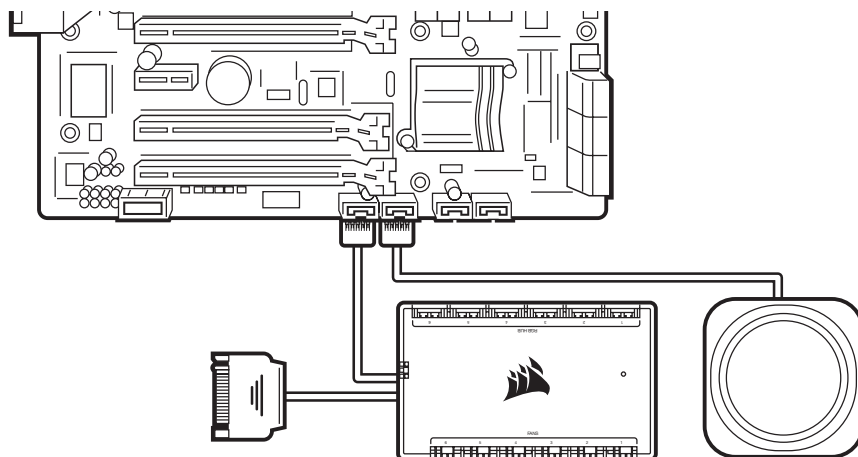

FAQ

1. How do I know the direction of the airflow of the fan?

An arrow located on the side of the fan indicates the direction of airflow.

2. Can I reuse the pre-applied thermal paste on the cooler for re-installation?

Re-installation of the cooler will require you to clean off the pre-applied thermal paste and re-apply the XTM70 thermal paste (sold separately).

3. What orientation should I install my radiator?

The best way to install a radiator is with the tubes on the bottom of the case, though you can install it with the tubes in any position, including an inverted radiator, as long as the highest point in the radiator is visibly higher than the CPU pump.

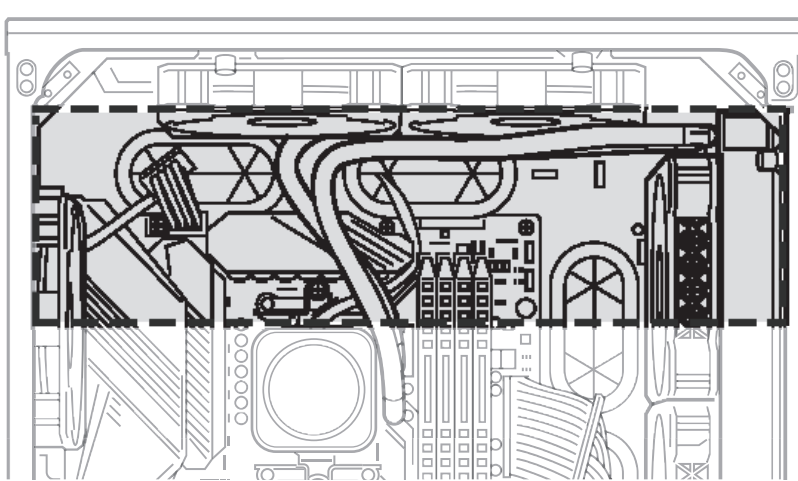

4. My cooler and fans are blinking red or not functioning. What do I do?

Please double check all connections from the cooler and fans to the Commander CORE.

Ensure that the Commander CORE and LCD module are update to the most recent firmware via iCUE. If this does not resolve your problems, please open a ticket at support.corsair.com or contact our customer support team for further troubleshooting and assistance.

<https://help.corsair.com/hc/en-us/requests/new>

5. What should I do if my cooler backplate feels loose after installation?

It is common for your cooler backplate to feel loose after you install it into your motherboard for the first time. Once you have seated and tightened down the cooler pump, it will pull the backplate to the motherboard and apply pressure on the socket via the cooler.

IMPORTANT: Do NOT, under any circumstances, add additional washers and spacers to your backplate to decrease play in the backplate. Doing so will increase the mounting pressure to the retention kit and potentially damage your retention kit, motherboard, or socket.

Remarque: La plupart des nouveaux boîtiers de PC comportent un accès facilité au processeur qui permet d'accéder à la base de la carte mère. Si aucun accès n'est prévu sur votre boîtier, vous devrez retirer votre carte mère du boîtier avant de procéder à l'installation. Les refroidisseurs ELITE LCD XT sont fournis avec le support de fixation Intel préinstallé sur la pompe afin de permettre une installation rapide.

TABLE DES MATIÈRES

INTEL (tous les sockets)

AMD AM5/AM4

AMD sTRX4

INSTALLATION



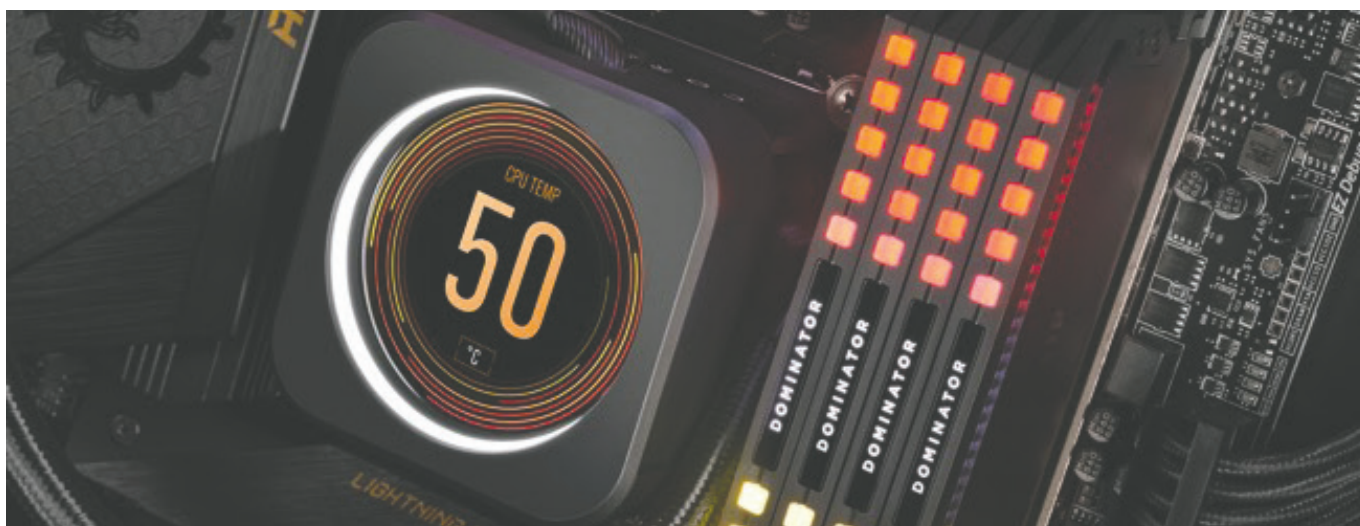





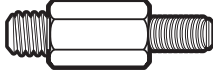

FAQ

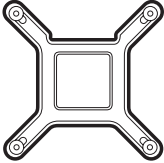
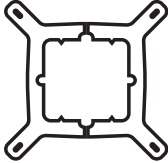
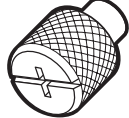

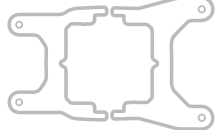
Avant l'installation, veuillez vous assurer que le PC est complètement hors tension. Le module LCD, la pompe et le COMMANDER CORE sont sensibles aux décharges électrostatiques et aux branchements à chaud.

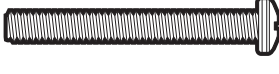
MATÉRIEL FOURNI

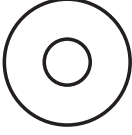
Les sections en surbrillance concernent uniquement l'installation Intel

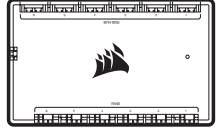
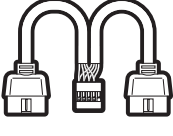
<p>A</p>  <p>x4 ENTRETOISES INTEL 1200/1150/1151/1156/1155</p>	<p>B</p>  <p>x4 ENTRETOISES INTEL 2011/2011-3/2066</p>	<p>C</p>  <p>x4 ENTRETOISES INTEL 1700</p>
<p>D</p>  <p>x1 PLAQUE ARRIÈRE INTEL</p>	<p>E</p>  <p>x1 SUPPORT DE FIXATION INTEL (PRÉINSTALLÉ)</p>	<p>F</p>  <p>x4 VIS MOLETÉES</p>
<p>G</p>  <p>x4 ENTRETOISES AMD AM5/AM4</p>	<p>H</p>  <p>x1 SUPPORT DE FIXATION AMD AM5/AM4</p>	<p>I</p>  <p>x1 SUPPORT DE FIXATION AMD sTR4/sTRX4</p>
<p>J</p>  <p>x4 ENTRETOISES AMD sTR4/sTRX4</p>	<p>K</p>  <p>x16 VIS DE VENTILATEUR LONGUES (H100i) x24 VIS DE VENTILATEUR LONGUES (H150i/ H170i)</p>	<p>L</p>  <p>x8 VIS DE RADIATEUR (H100i) x12 VIS DE RADIATEUR (H150i/H170i)</p>
<p>M</p>  <p>x8 RONDELLES (H100i) x12 RONDELLES (H150i/H170i)</p>	<p>N</p>  <p>x2 VENTILATEURS AF RGB ELITE (H100i) x3 VENTILATEURS AF RGB ELITE (H150i/H170i)</p>	<p>O</p>  <p>COMMANDER CORE</p>
<p>P</p>  <p>SÉPARATEUR EN Y USB</p>		

1. INSTALLATION DE LA PLAQUE ARRIÈRE INTEL

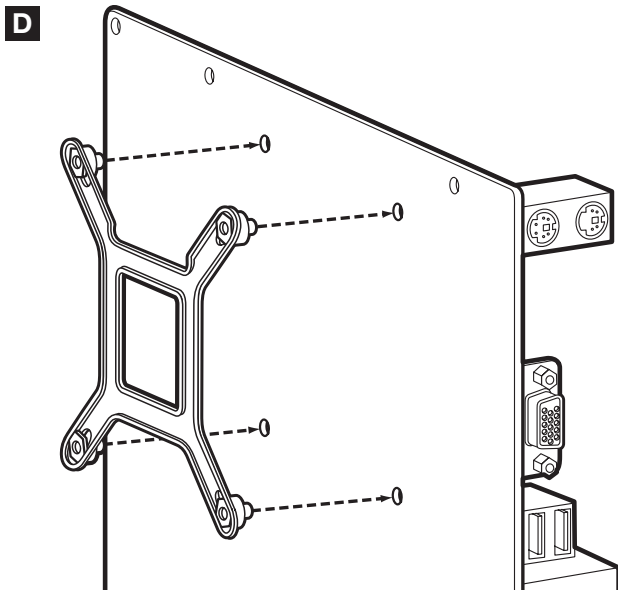

Ajustez la plaque arrière pour votre socket.

Remarque : l'installation de la plaque arrière n'est pas requise pour le modèle Intel LGA 2011/2011-3/2066.

Passez à l'étape 2.

2. INSTALLATION DES VIS À ENTRETOISE INTEL

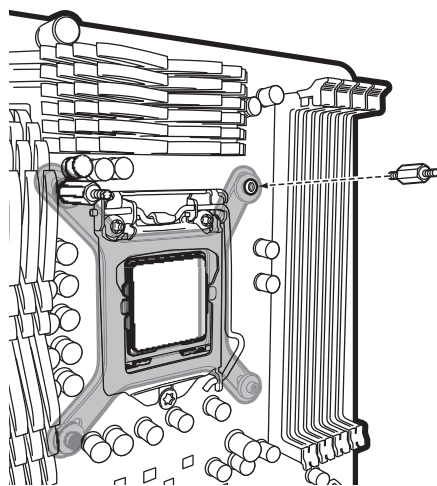

A LGA 1200/1150/
1151/1155/1156

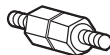

B LGA 2011/
2011-3/2066

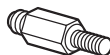

C LGA 1700

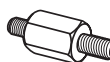

- > Attachez les entretoises Intel fournies pour votre prise.
- > Utilisez (A) pour le modèle LGA 1200/115X, (B) pour LGA 2011/2011-3/2066 ou (C) pour LGA 1700.
- > Serrez les quatre vis jusqu'à ce qu'elles soient solidement fixées.

3. INSTALLATION DES VENTILATEURS ET DU RADIATEUR

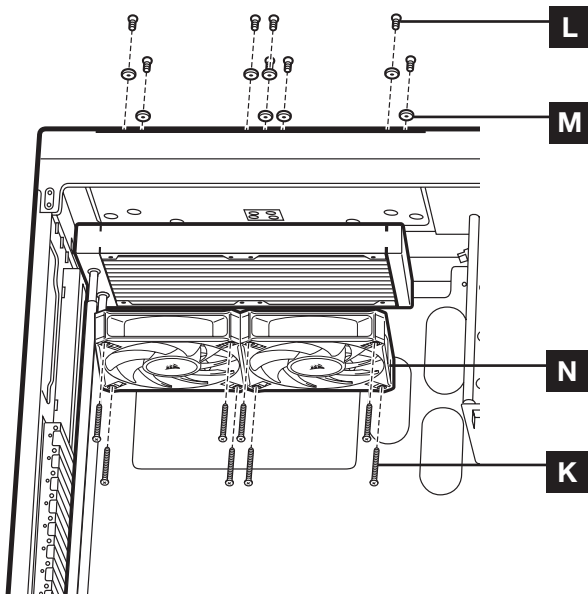

Fixez le radiateur et les ventilateurs comme indiqué. Pour des performances de refroidissement optimales, nous vous recommandons d'installer les ventilateurs comme une entrée d'air sur la tour de votre ordinateur.

4. INSTALLATION DE LA POMPE

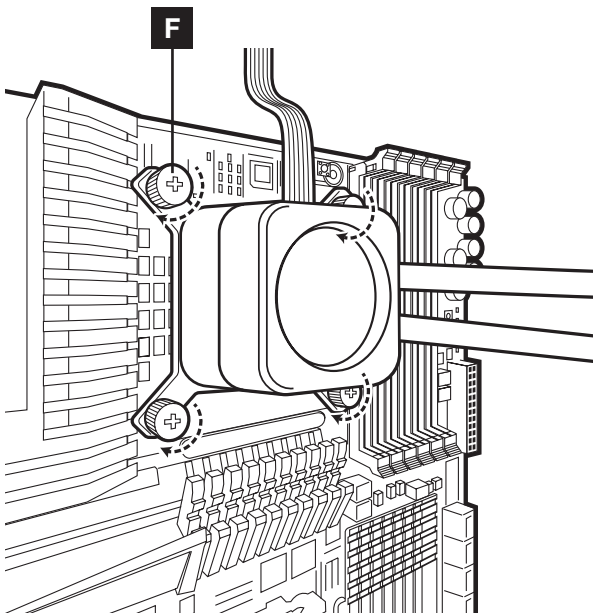





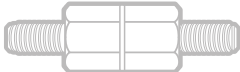
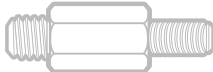

- > Alignez le support et la pompe avec les vis à entretoise comme indiqué.
- > Attachez les vis moletées (F) sur les vis à entretoise comme indiqué.
- > Serrez les vis moletées jusqu'à ce que les quatre coins soient solidement fixés.

Veuillez passer à la page 10 pour procéder à la suite de l'installation.

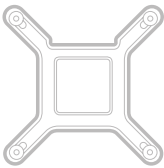
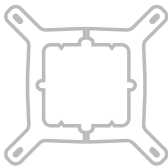
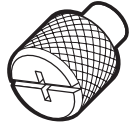
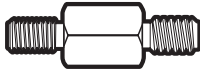
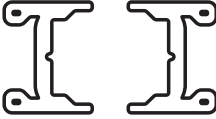
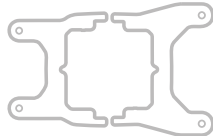
MATÉRIEL FOURNI

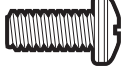
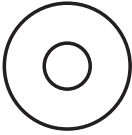
Les sections en surbrillance concernent uniquement l'installation AMD AM5/AM4

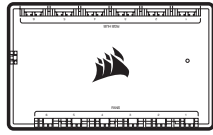
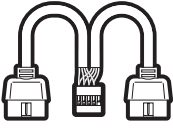
<p>A</p>  <p>x4 ENTRETOISES INTEL 1200/1150/1151/1156/1155</p>	<p>B</p>  <p>x4 ENTRETOISES INTEL 2011/2011-3/2066</p>	<p>C</p>  <p>x4 ENTRETOISES INTEL 1700</p>
<p>D</p>  <p>x1 PLAQUE ARRIÈRE INTEL</p>	<p>E</p>  <p>x1 SUPPORT DE FIXATION INTEL (PRÉINSTALLÉ)</p>	<p>F</p>  <p>x4 VIS MOLETÉES</p>
<p>G</p>  <p>x4 ENTRETOISES AMD AM5/AM4</p>	<p>H</p>  <p>x1 SUPPORT DE FIXATION AMD AM5/AM4</p>	<p>I</p>  <p>x1 SUPPORT DE FIXATION AMD sTR4/sTRX4</p>
<p>J</p>  <p>x4 ENTRETOISES AMD sTR4/sTRX4</p>	<p>K</p>  <p>x16 VIS DE VENTILATEUR LONGUES (H100i) x24 VIS DE VENTILATEUR LONGUES (H150i/ H170i)</p>	<p>L</p>  <p>x8 VIS DE RADIATEUR (H100i) x12 VIS DE RADIATEUR (H150i/H170i)</p>
<p>M</p>  <p>x8 RONDELLES (H100i) x12 RONDELLES (H150i/H170i)</p>	<p>N</p>  <p>x2 VENTILATEURS AF RGB ELITE (H100i) x3 VENTILATEURS AF RGB ELITE (H150i/H170i)</p>	<p>O</p>  <p>COMMANDER CORE</p>
<p>P</p>  <p>SÉPARATEUR EN Y USB</p>		

1. INSTALLATION DU SUPPORT DE FIXATION AMD AM5/AM4

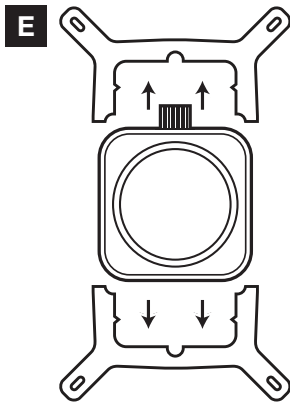

Figure 1

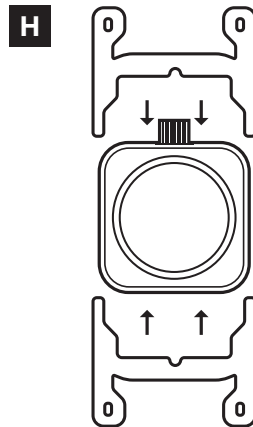
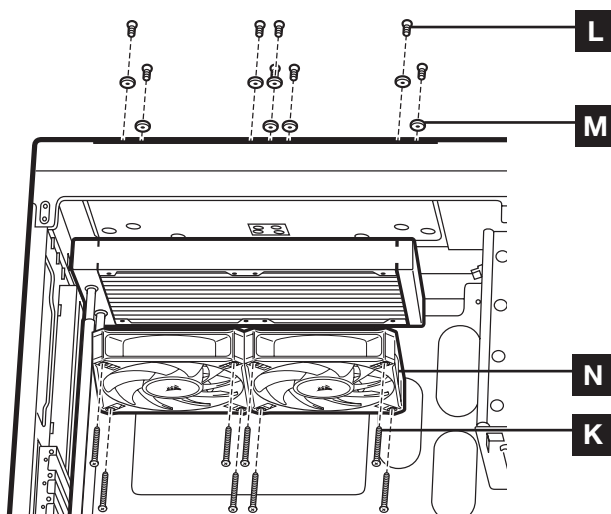

Figure 2

- > Retirez le support de fixation intégré Intel (figure 1).
- > Installez le support AMD AM5/AM4 en poussant les deux côtés dans le slot de la pompe jusqu'à la butée (figure 2).

Remarque: il est important que le support de retenue AMD AM5/AM4 soit bien sécurisé des deux côtés avant de procéder à l'installation.

2. INSTALLATION DES VENTILATEURS ET DU RADIATEUR



Fixez le radiateur et les ventilateurs comme indiqué. Pour des performances de refroidissement optimales, nous vous recommandons d'installer les ventilateurs comme une entrée d'air sur la tour de votre ordinateur.

3. PRÉPARER LA CARTE MÈRE POUR L'INSTALLATION

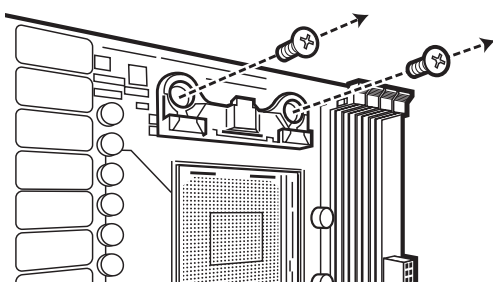

Retirez les supports de fixation AMD AM5/AM4 existants indiqués.

4. INSTALLATION DES VIS À ENTRETOISE ADM AM5/AM4

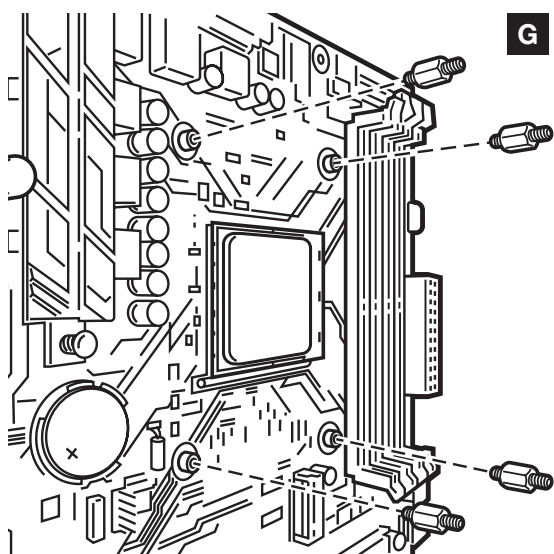

- > Placez les entretoises AMD AM5/AM4 fournies dans le socket de processeur.
- > Serrez les quatre vis jusqu'à ce qu'elles soient solidement fixées.

5. INSTALLATION DE LA POMPE

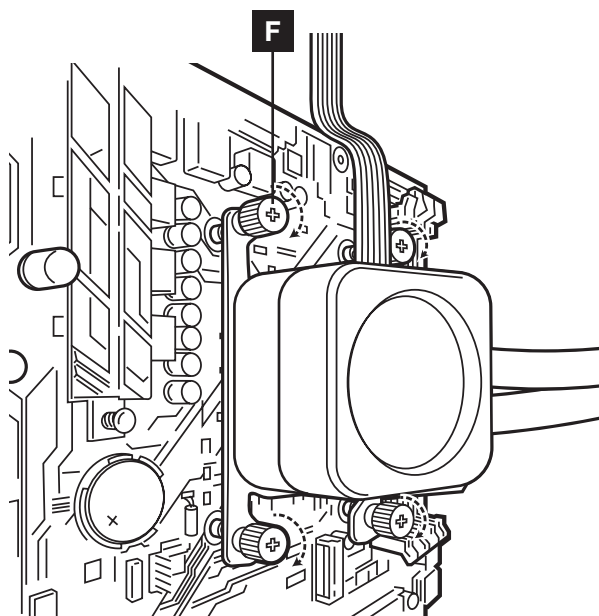







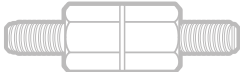
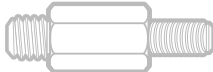

Alignez le support avec les entretoises AMD AM5/AM4 comme indiqué. Serrez bien les vis moletées (F).

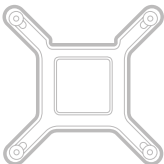
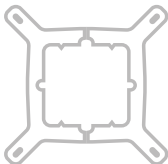
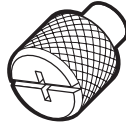
Veuillez passer à la page 10 pour procéder à la suite de l'installation.

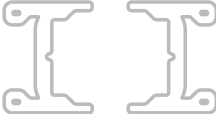
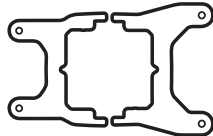
INCLUDED HARDWARE

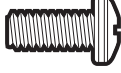
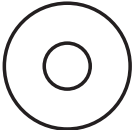
Les sections en surbrillance concernent uniquement l'installation AMD sTRX4.

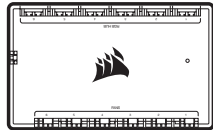
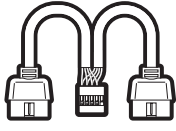
<p>A</p>  <p>x4 ENTRETOISES INTEL 1200/1150/1151/1156/1155</p>	<p>B</p>  <p>x4 ENTRETOISES INTEL 2011/2011-3/2066</p>	<p>C</p>  <p>x4 ENTRETOISES INTEL 1700</p>
<p>D</p>  <p>x1 PLAQUE ARRIÈRE INTEL</p>	<p>E</p>  <p>x1 SUPPORT DE FIXATION INTEL (PRÉINSTALLÉ)</p>	<p>F</p>  <p>x4 VIS MOLETÉES</p>
<p>G</p>  <p>x4 ENTRETOISES AMD AM5/AM4</p>	<p>H</p>  <p>x1 SUPPORT DE FIXATION AMD AM5/AM4</p>	<p>I</p>  <p>x1 SUPPORT DE FIXATION AMD sTR4/sTRX4</p>
<p>J</p>  <p>x4 ENTRETOISES AMD sTR4/sTRX4</p>	<p>K</p>  <p>x16 VIS DE VENTILATEUR LONGUES (H100i) x24 VIS DE VENTILATEUR LONGUES (H150i/ H170i)</p>	<p>L</p>  <p>x8 VIS DE RADIATEUR (H100i) x12 VIS DE RADIATEUR (H150i/H170i)</p>
<p>M</p>  <p>x8 RONDELLES (H100i) x12 RONDELLES (H150i/H170i)</p>	<p>N</p>  <p>x2 VENTILATEURS AF RGB ELITE (H100i) x3 VENTILATEURS AF RGB ELITE (H150i/H170i)</p>	<p>O</p>  <p>COMMANDER CORE</p>
<p>P</p>  <p>SÉPARATEUR EN Y USB</p>		

1. INSTALLATION DU SUPPORT DE FIXATION AMD sTRX4

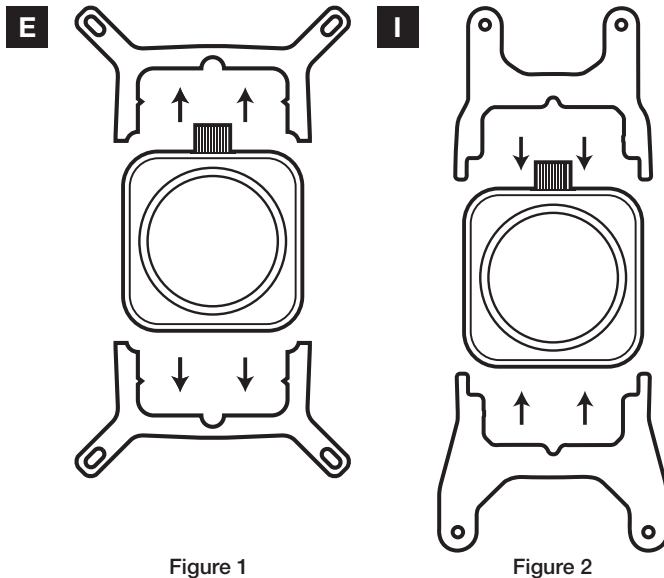

Figure 1

Figure 2

- > Retirez le support de fixation intégré Intel (figure 1).
- > Installez le support AMD sTRX4 en poussant les deux côtés dans le slot de la pompe jusqu'à la butée (figure 2).

Remarque: il est important que le support de retenue AMD sTRX4 soit bien sécurisé des deux côtés avant de procéder à l'installation.

2. INSTALLATION DES VIS À ENTRETOISE ADM sTRX4

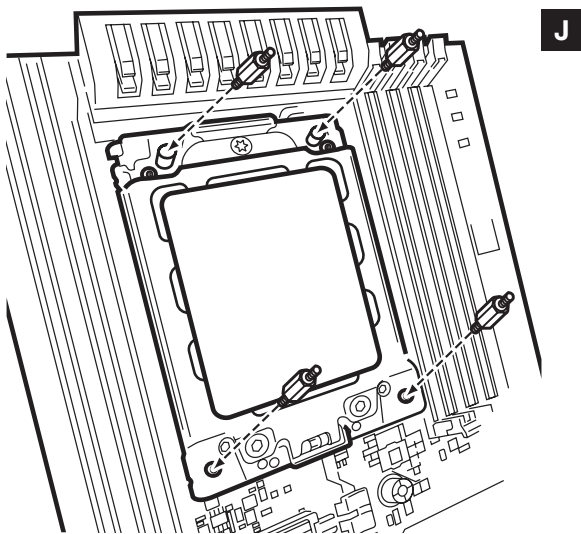

- > Placez les entretoises AMD sTRX4 fournies dans le socket de processeur.
- > Serrez les quatre vis jusqu'à ce qu'elles soient solidement fixées.

3. INSTALLATION DES VENTILATEURS ET DU RADIATEUR

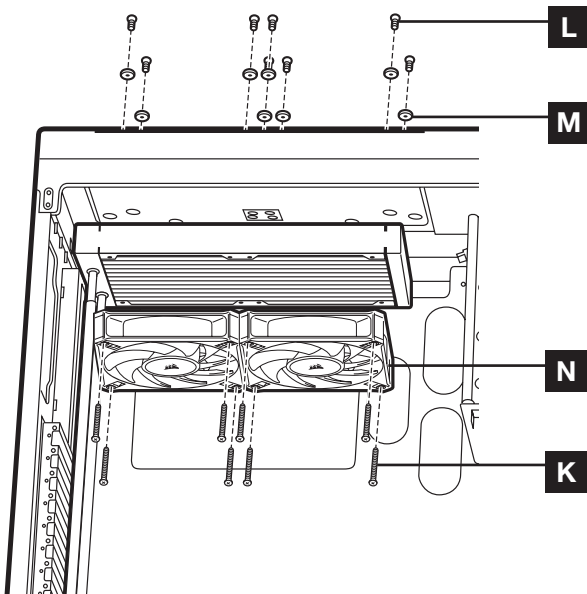

Fixez le radiateur et les ventilateurs comme indiqué. Pour des performances de refroidissement optimales, nous vous recommandons d'installer les ventilateurs comme une entrée d'air sur la tour de votre ordinateur.

4. INSTALLATION DE LA POMPE

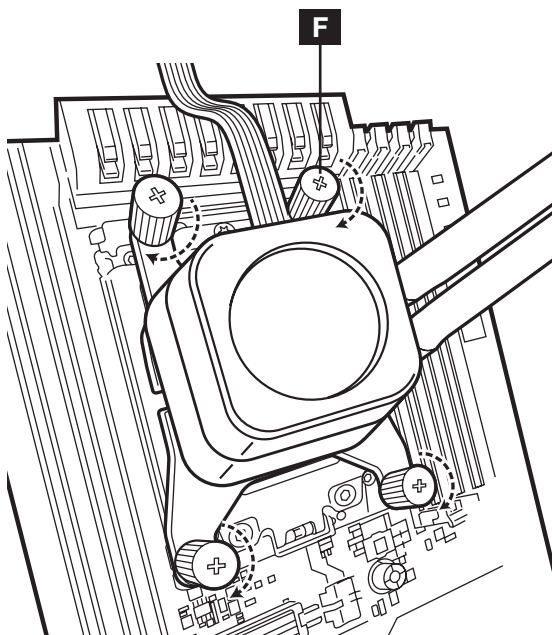

- > Alignez le support et la pompe avec les vis à entretoise comme indiqué.
- > Attachez les vis moletées (F) sur les vis à entretoise comme indiqué.
- > Serrez les vis moletées jusqu'à ce que les quatre coins soient solidement fixés.

Veuillez passer à la page 10 pour procéder à la suite de l'installation.

CONNECTER LES VENTILATEURS ET LA POMPE AU COMMANDER CORE

- > Connectez le câble 24 broches de la pompe à votre COMMANDER CORE (figure 1).
- > Connectez le câble tachymètre de la pompe au cavalier CPU_FAN de votre carte mère (figure 2).
- > Connectez chaque ventilateur au COMMANDER CORE (figure 3).
- > Connectez chaque fiche RGB de ventilateur au COMMANDER CORE (figure 3).

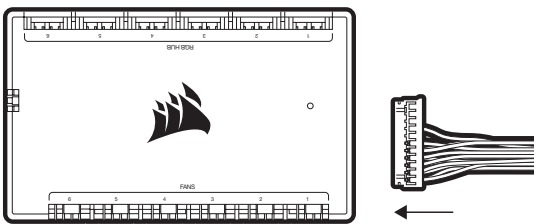

Figure 1

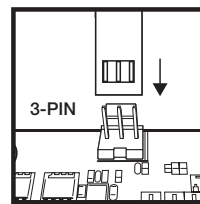

Figure 2

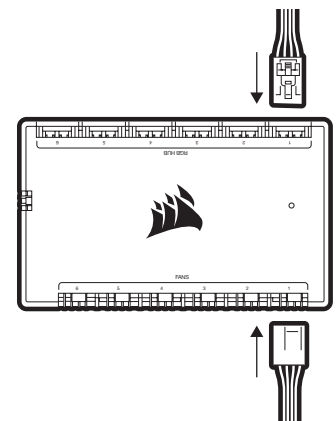
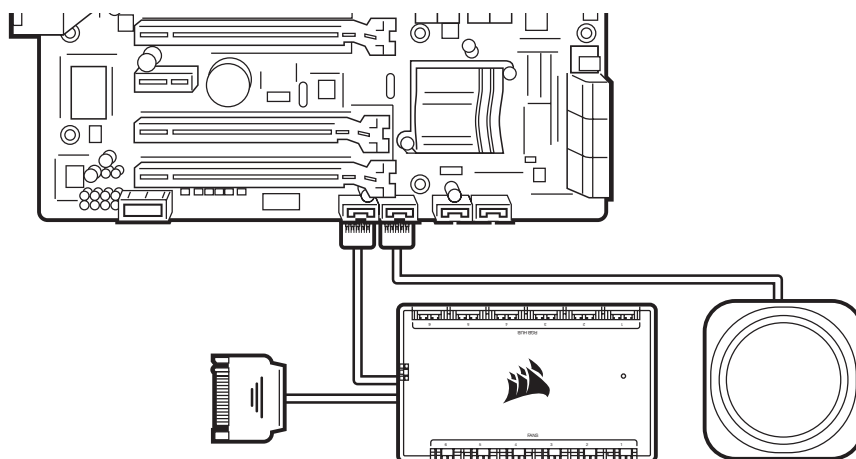

Figure 3

CONNECTER LE COMMANDER CORE ET LE MODULE ELITE LCD XT À L'ALIMENTATION ET AU CAVALIER USB 2.0

- > À l'aide du câble USB joint, reliez le COMMANDER CORE à un cavalier USB 2.0 de la carte mère.
- > Connectez le câble d'alimentation de la pompe à une fiche d'alimentation SATA disponible de votre bloc d'alimentation.
- > Installez le séparateur en Y USB fourni pour n'utiliser qu'un seul port USB au lieu des deux requis.



FAQ

1. Comment savoir dans quelle direction le flux d'air du ventilateur se déplace ?

Une flèche située sur le côté du ventilateur indique la direction du flux d'air.

2. Puis-je réutiliser la pâte thermique pré-appliquée sur le refroidisseur en vue d'effectuer une nouvelle installation ?

Pour réinstaller le refroidisseur, il vous faudra d'abord nettoyer la pâte thermique pré-appliquée pour ensuite réappliquer la pâte thermique XTM70 (vendue séparément).

3. Quelle orientation dois-je choisir en installant mon radiateur ?

Le meilleur moyen d'installer un radiateur est avec les tubes en bas du boîtier, même si vous pouvez l'installer avec les tubes dans n'importe quelle position, dont un radiateur inversé, tant que le point supérieur du radiateur dépasse la pompe du processeur.

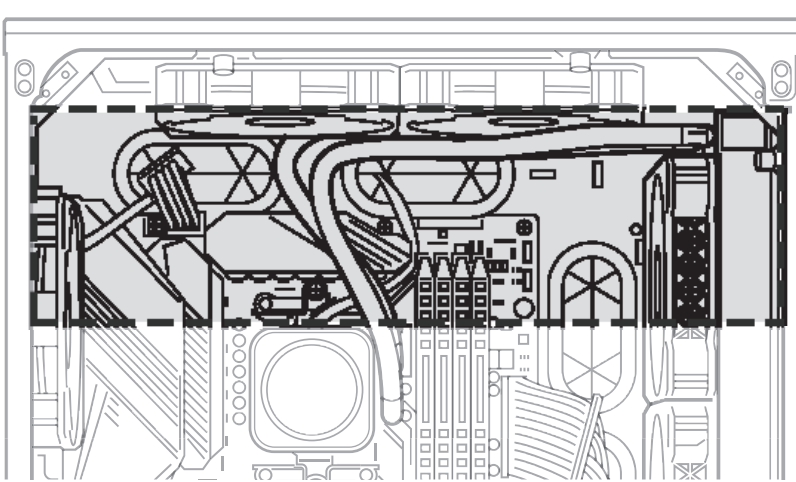
**4. Mon refroidisseur et mes ventilateurs clignotent en rouge ou ne fonctionnent pas. Que dois-je faire ?**

Veillez vérifier toutes les connexions du refroidisseur et des ventilateurs avec COMMANDER CORE. Assurez-vous que COMMANDER CORE et le module LCD sont mis à jour au micrologiciel le plus récent via l'iCUE. Si cela ne résout pas vos problèmes, veuillez ouvrir un ticket à l'adresse support.corsair.com ou contacter notre équipe d'assistance client pour obtenir davantage d'aide pour la résolution des problèmes.

<https://help.corsair.com/hc/en-us/requests/new>

5. Que faire si la plaque arrière de mon refroidisseur semble mal fixée après l'installation ?

Il arrive fréquemment que la plaque arrière du refroidisseur donne l'impression d'être mal fixée après la première installation dans la carte mère. Une fois que la pompe du refroidisseur est installée et serrée, elle tire la plaque arrière vers la carte mère et exerce une pression sur le socket via le refroidisseur.

IMPORTANT: n'ajoutez **EN AUCUN CAS** des rondelles et des écarteurs supplémentaires à votre plaque arrière pour en réduire le jeu. Cela augmenterait la pression de montage du kit de retenue, ce qui pourrait endommager le kit de retenue, la carte mère ou le socket.

Hinweis: Bei neueren PC-Gehäusen gibt in der Regel eine CPU-Öffnung Zugang zur Unterseite der Hauptplatine. Falls Ihr Gehäuse keine derartige Öffnung aufweist, müssen Sie vor der Installation die Hauptplatine ausbauen. Bei ELITE LCD XT-Kühlsystemen wird eine Intel-Montagehalterung mitgeliefert, die an der Pumpe vorinstalliert ist und dadurch eine schnelle Montage ermöglicht.

INHALTSVERZEICHNIS

INTEL (alle Socket)

AMD AM5/AM4

AMD sTRX4

INSTALLATION







FAQ

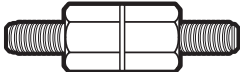
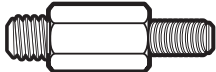
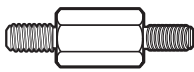
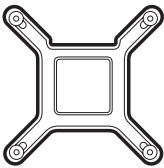
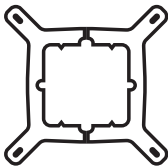
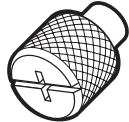

Schalten Sie unbedingt Ihren gesamten PC aus, bevor Sie mit der Installation beginnen. Das LCD-Modul, die Pumpe und der COMMANDER CORE sind empfindlich gegenüber Hotplugging und elektrostatischer Entladung.

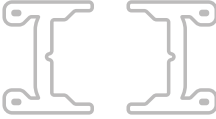
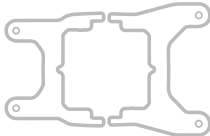
INBEGRIFFENE HARDWARE

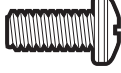
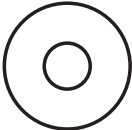
Die markierten Passagen beziehen sich nur auf die Intel-Installation.

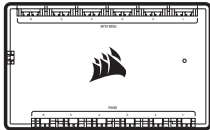
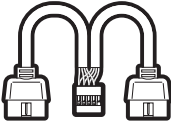
<p>A</p>  <p>4x INTEL 1200/1150/1151/1156/1155 ABSTANDSSCHRAUBEN</p>	<p>B</p>  <p>4x INTEL 2011/2011-3/2066 ABSTANDSSCHRAUBEN</p>	<p>C</p>  <p>4x INTEL 1700 ABSTANDSSCHRAUBEN</p>
<p>D</p>  <p>1x INTEL-BACKPLATE</p>	<p>E</p>  <p>1x INTEL MONTAGEHALTERUNG (VORINSTALLIERT)</p>	<p>F</p>  <p>4x RÄNDELSCHRAUBEN</p>
<p>G</p>  <p>4x AMD AM5/AM4 ABSTANDSSCHRAUBEN</p>	<p>H</p>  <p>1x AMD AM5/AM4 MONTAGEHALTERUNG</p>	<p>I</p>  <p>1x AMD sTR4/sTRX4 MONTAGEHALTERUNG</p>
<p>J</p>  <p>4x AMD sTR4/sTRX4 ABSTANDSSCHRAUBEN</p>	<p>K</p>  <p>16x LANGE LÜFTERSCHRAUBEN (H100i) 24x LANGE LÜFTERSCHRAUBEN (H150i/H170i)</p>	<p>L</p>  <p>8x RADIATORSCHRAUBEN (H100i) 12x RADIATORSCHRAUBEN (H150i/H170i)</p>
<p>M</p>  <p>8x UNTERLEGSCHIBEN (H100i) 12x UNTERLEGSCHIBEN (H150i/H170i)</p>	<p>N</p>  <p>2x AF RGB ELITE-LÜFTER (H100i) 3x AF RGB ELITE-LÜFTER (H150i/H170i)</p>	<p>O</p>  <p>COMMANDER CORE</p>
<p>P</p>  <p>USB-Y-SPLITTER</p>		

1. INTEL-BACKPLATE ANBRINGEN

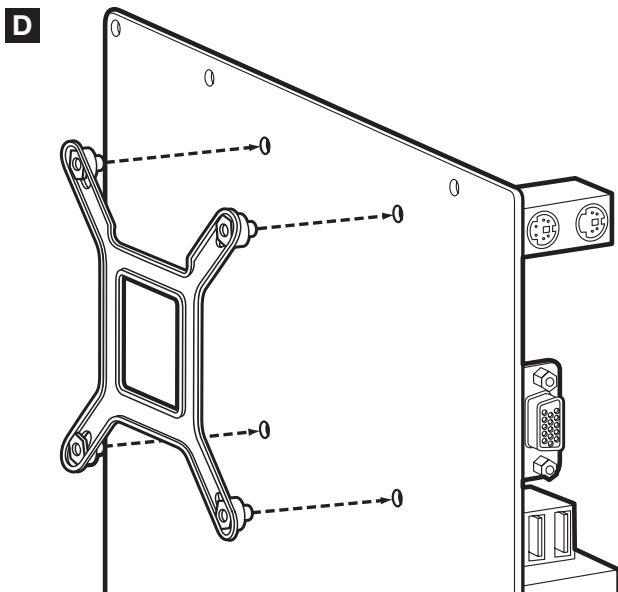

Stellen Sie die Backplate auf den gewünschten Sockel ein.

Hinweis: Intel LGA 2011/2011-3/2066 erfordern keine Anbringung der Backplate.

Fahren Sie mit Schritt 2 fort.

2. INTEL-ABSTANDSSCHRAUBEN ANBRINGEN

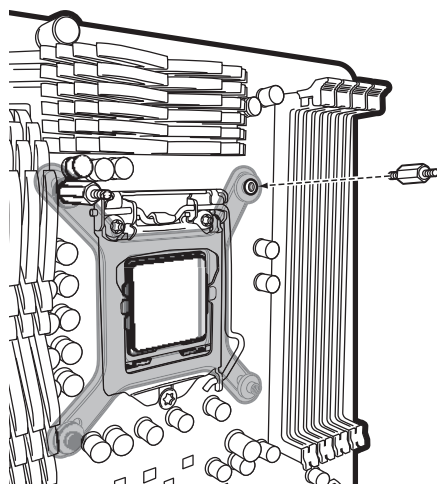

A LGA 1200/1150/
1151/1155/1156

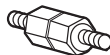

B LGA 2011/
2011-3/2066

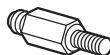

C LGA 1700

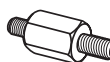

- > Bringen Sie die für den Sockel mitgelieferten Intel-Abstandsschrauben an.
- > Verwenden Sie (A) für LGA 1200/115X, (B) für LGA 2011/2011-3/2066 oder (C) für LGA 1700.
- > Ziehen Sie alle vier Schrauben fest.

3. LÜFTER UND RADIATOR EINBAUEN

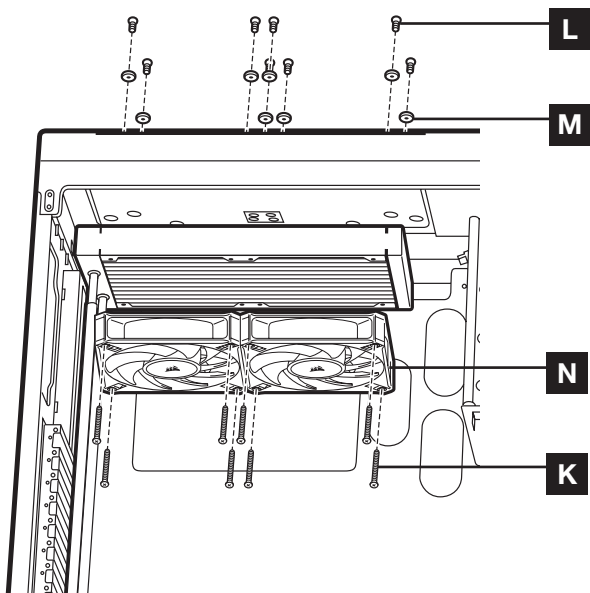

Befestigen Sie wie abgebildet den Radiator und die Lüfter. Für bestmögliche Kühlleistung empfehlen wir, die Lüfter als Lufteinlass des PC-Gehäuses zu montieren.

4. PUMPENEINHEIT INSTALLIEREN

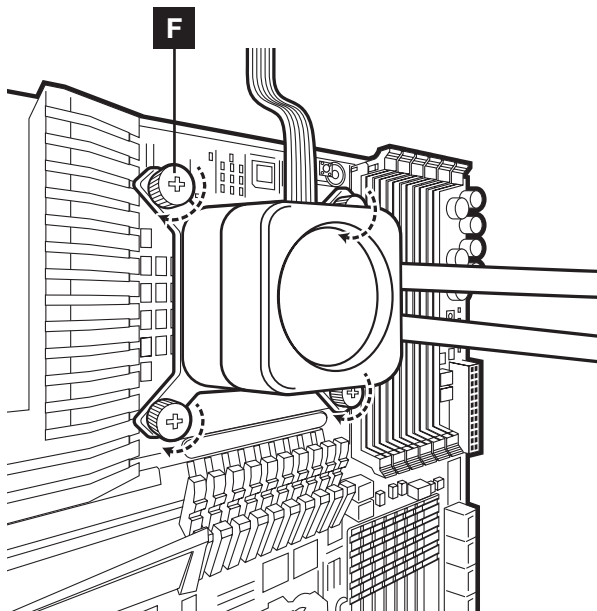







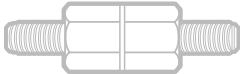

- > Richten Sie die Halterung und die Pumpe wie abgebildet über den Abstandsschrauben aus.
- > Bringen Sie die Rändelschrauben (F) wie abgebildet an den Abstandsschrauben an.
- > Ziehen Sie die Rändelrauben an, bis alle vier Ecken fest sitzen.

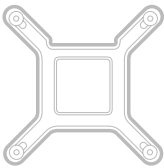
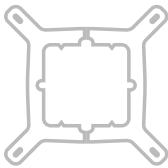
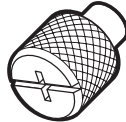
Bitte fahren Sie auf Seite 10 mit der Installation fort.

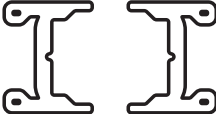
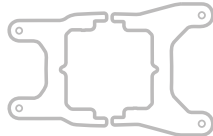
INBEGRIFFENE HARDWARE

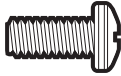
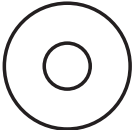
Die markierten Passagen beziehen sich nur auf die AMD AM5/AM4-Installation.

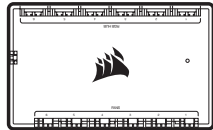
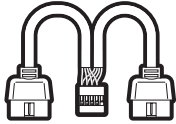
<p>A</p>  <p>4x INTEL 1200/1150/1151/1156/1155 ABSTANDSSCHRAUBEN</p>	<p>B</p>  <p>4x INTEL 2011/2011-3/2066 ABSTANDSSCHRAUBEN</p>	<p>C</p>  <p>4x INTEL 1700 ABSTANDSSCHRAUBEN</p>
<p>D</p>  <p>1x INTEL-BACKPLATE</p>	<p>E</p>  <p>1x INTEL MONTAGEHALTERUNG (VORINSTALLIERT)</p>	<p>F</p>  <p>4x RÄNDELSCHRAUBEN</p>
<p>G</p>  <p>4x AMD AM5/AM4 ABSTANDSSCHRAUBEN</p>	<p>H</p>  <p>1x AMD AM5/AM4 MONTAGEHALTERUNG</p>	<p>I</p>  <p>1x AMD sTR4/sTRX4 MONTAGEHALTERUNG</p>
<p>J</p>  <p>4x AMD sTR4/sTRX4 ABSTANDSSCHRAUBEN</p>	<p>K</p>  <p>16x LANGE LÜFTERSCHRAUBEN (H100i) 24x LANGE LÜFTERSCHRAUBEN (H150i/H170i)</p>	<p>L</p>  <p>8x RADIATORSCHRAUBEN (H100i) 12x RADIATORSCHRAUBEN (H150i/H170i)</p>
<p>M</p>  <p>8x UNTERLEGSCHIEBEN (H100i) 12x UNTERLEGSCHIEBEN (H150i/H170i)</p>	<p>N</p>  <p>2x AF RGB ELITE-LÜFTER (H100i) 3x AF RGB ELITE-LÜFTER (H150i/H170i)</p>	<p>O</p>  <p>COMMANDER CORE</p>
<p>P</p>  <p>USB-Y-SPLITTER</p>		

1. AMD AM5/AM4-MONTAGEHALTERUNG INSTALLIEREN



Abbildung 1



Abbildung 2

- > Entfernen Sie die integrierte Intel-Montagehalterung (Abbildung 1).
- > Bringen Sie die AMD AM5/AM4-Halterung an, indem Sie beide Seiten in die Vertiefung an der Pumpe drücken, bis sie fest sitzt (Abbildung 2).

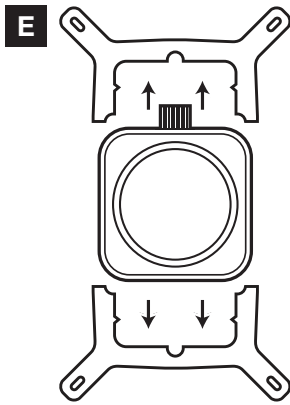
Hinweis: Stellen Sie vor der Installation unbedingt sicher, dass die AMD AM5/AM4-Halteklammer an allen Seiten sicher sitzt.

2. LÜFTER UND RADIATOR EINBAUEN

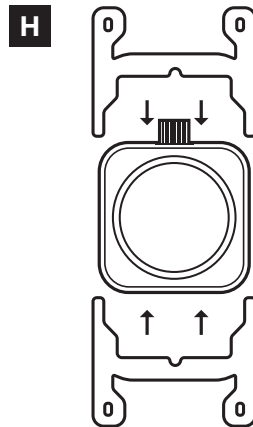
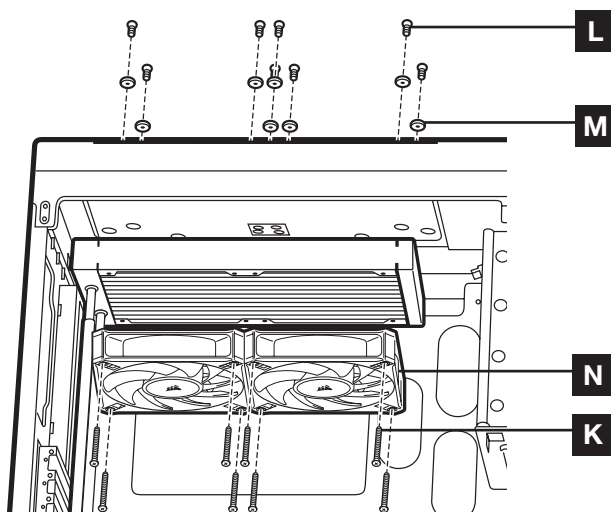

Befestigen Sie wie abgebildet den Radiator und die Lüfter. Für bestmögliche Kühlleistung empfehlen wir, die Lüfter als Lufteinlass des PC-Gehäuses zu montieren.

3. HAUPTPLATINE FÜR DIE INSTALLATION VORBEREITEN

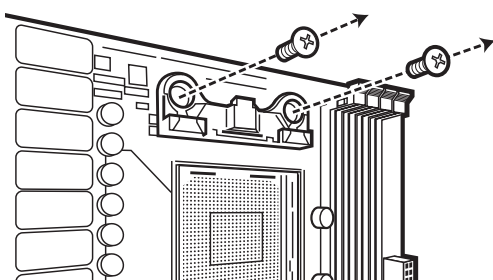

Entfernen Sie die vorhandenen AMD AM5/AM4-Montagehalterungen wie abgebildet.

4. AMD AM5/AM4-ABSTANDSSCHRAUBEN ANBRINGEN

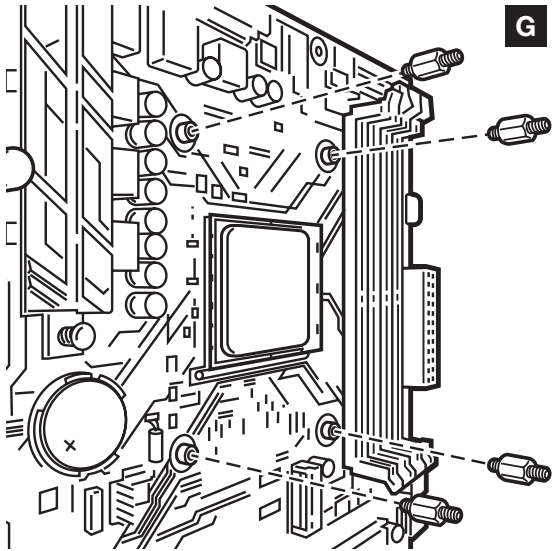

- > Bringen Sie die mitgelieferten AMD AM5/AM4-Abstandsschrauben am CPU-Sockel an.
- > Ziehen Sie alle vier Schrauben fest.

5. PUMPENEINHEIT INSTALLIEREN

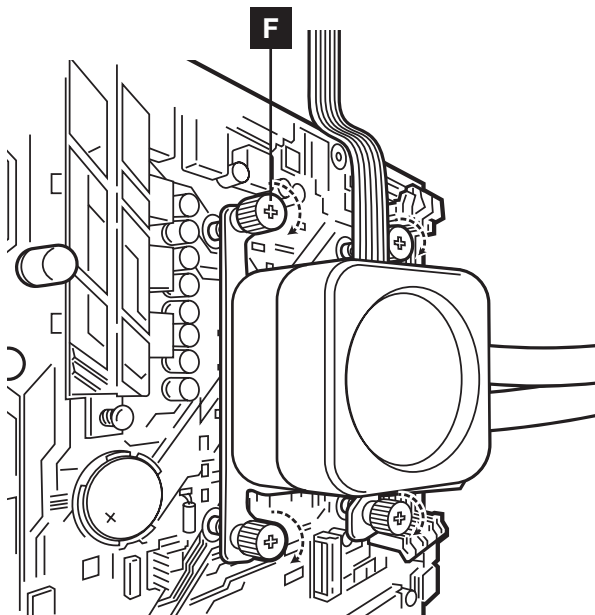







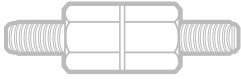

Richten Sie die Halterung wie abgebildet an den AMD AM5/AM4-Abstandsschrauben aus. Ziehen Sie die Rändelschrauben (F) nun fest an.

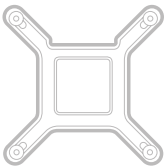
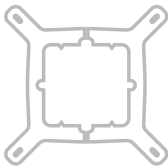
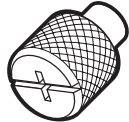
Bitte fahren Sie auf Seite 10 mit der Installation fort.

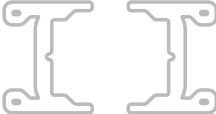
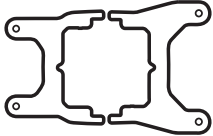
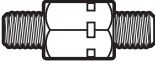
INBEGRIFFENE HARDWARE

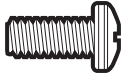
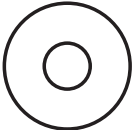
Die markierten Passagen beziehen sich nur auf die AMD sTRX4-Installation.

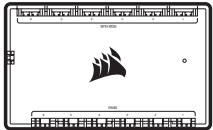
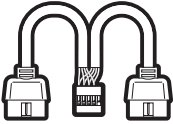
<p>A</p>  <p>4x INTEL 1200/1150/1151/1156/1155 ABSTANDSSCHRAUBEN</p>	<p>B</p>  <p>4x INTEL 2011/2011-3/2066 ABSTANDSSCHRAUBEN</p>	<p>C</p>  <p>4x INTEL 1700 ABSTANDSSCHRAUBEN</p>
<p>D</p>  <p>1x INTEL-BACKPLATE</p>	<p>E</p>  <p>1x INTEL MONTAGEHALTERUNG (VORINSTALLIERT)</p>	<p>F</p>  <p>4x RÄNDELSCHRAUBEN</p>
<p>G</p>  <p>4x AMD AM5/AM4 ABSTANDSSCHRAUBEN</p>	<p>H</p>  <p>1x AMD AM5/AM4 MONTAGEHALTERUNG</p>	<p>I</p>  <p>1x AMD sTR4/sTRX4 MONTAGEHALTERUNG</p>
<p>J</p>  <p>4x AMD sTR4/sTRX4 ABSTANDSSCHRAUBEN</p>	<p>K</p>  <p>16x LANGE LÜFTERSCHRAUBEN (H100i) 24x LANGE LÜFTERSCHRAUBEN (H150i/H170i)</p>	<p>L</p>  <p>8x RADIATORSCHRAUBEN (H100i) 12x RADIATORSCHRAUBEN (H150i/H170i)</p>
<p>M</p>  <p>8x UNTERLEGSCHEBEN (H100i) 12x UNTERLEGSCHEBEN (H150i/H170i)</p>	<p>N</p>  <p>2x AF RGB ELITE-LÜFTER (H100i) 3x AF RGB ELITE-LÜFTER (H150i/H170i)</p>	<p>O</p>  <p>COMMANDER CORE</p>
<p>P</p>  <p>USB-Y-SPLITTER</p>		

1. AMD sTRX4-MONTAGEHALTERUNG INSTALLIEREN

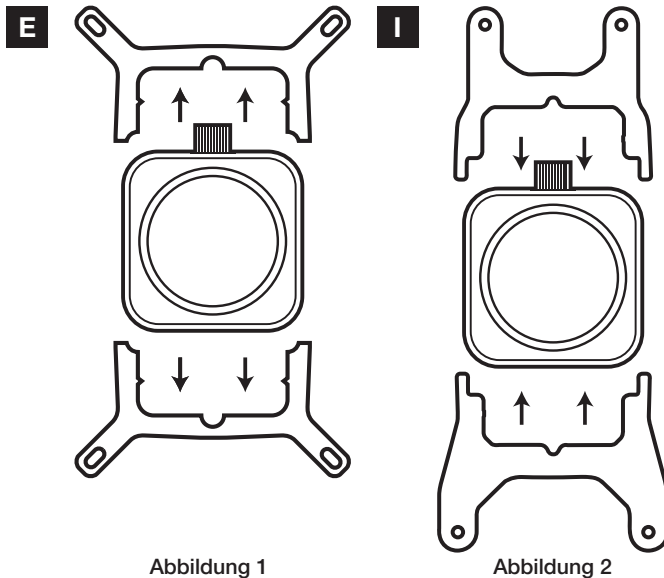

- > Entfernen Sie die integrierte Intel-Montagehalterung (Abbildung 1).
- > Bringen Sie die AMD sTRX4-Halterung an, indem Sie beide Seiten in die Vertiefung an der Pumpe drücken, bis sie fest sitzt (Abbildung 2).

Hinweis: Stellen Sie vor der Installation unbedingt sicher, dass die AMD sTRX4-Halteklammer an allen Seiten sicher sitzt.

2. AMD sTRX4-ABSTANDSSCHRAUBEN ANBRINGEN

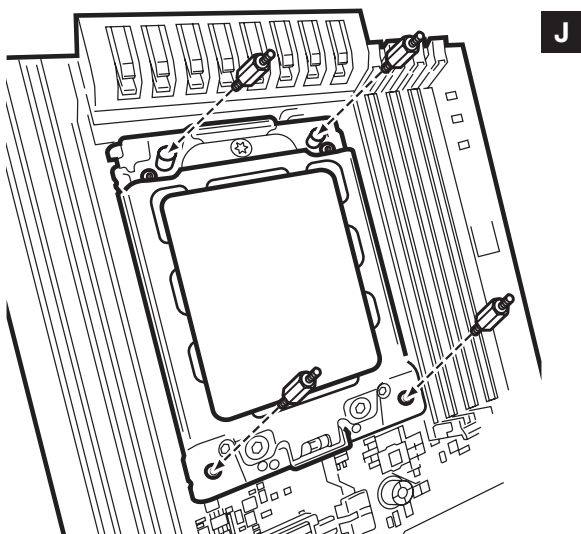

- > Bringen Sie die mitgelieferten AMD sTRX4-Abstandsschrauben am CPU-Sockel an.
- > Ziehen Sie alle vier Schrauben fest.

3. LÜFTER UND RADIATOR EINBAUEN

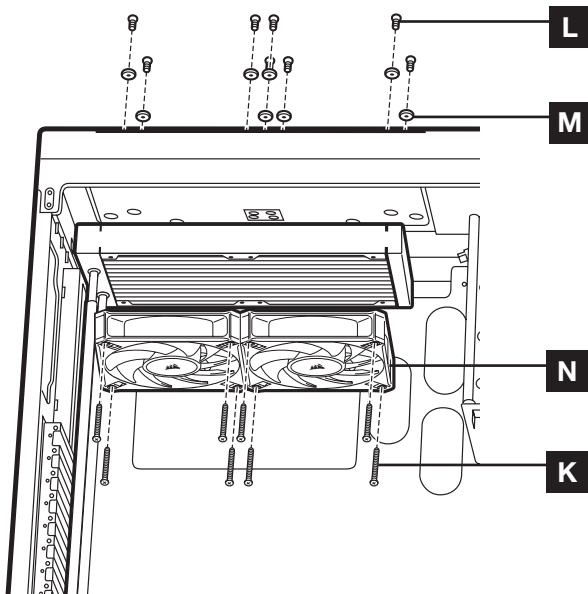

Befestigen Sie wie abgebildet den Radiator und die Lüfter. Für bestmögliche Kühlleistung empfehlen wir, die Lüfter als Lufteinlass des PC-Gehäuses zu montieren.

4. PUMPENEINHEIT INSTALLIEREN

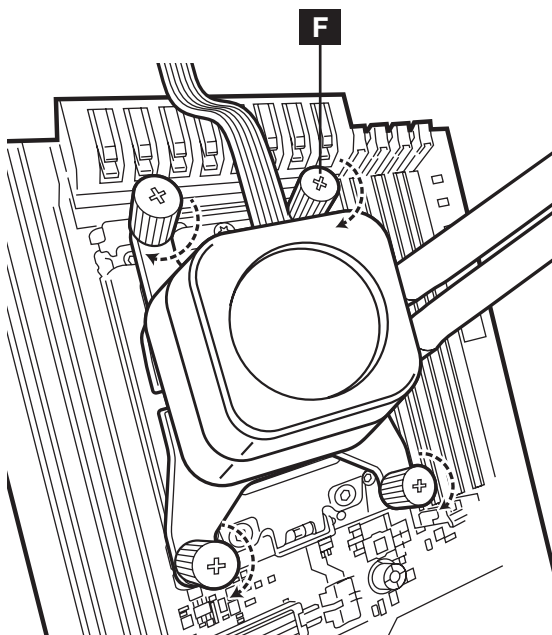

- > Richten Sie die Halterung und die Pumpe wie abgebildet über den Abstandsschrauben aus.
- > Bringen Sie die Rändelschrauben (F) wie abgebildet an den Abstandsschrauben an.
- > Ziehen Sie die Rändelrauben an, bis alle vier Ecken fest sitzen.

Bitte fahren Sie auf Seite 10 mit der Installation fort.

LÜFTER UND PUMPE MIT COMMANDER CORE VERBINDEN

- > Verbinden Sie das 24-polige Pumpenkabel mit Ihrem COMMANDER CORE (Abbildung 1).
- > Verbinden Sie das Tachokabel der Pumpe mit dem CPU_FAN-Anschluss an Ihrer Hauptplatine (Abbildung 2).
- > Verbinden Sie jeden Lüfter mit dem COMMANDER CORE (Abbildung 3).
- > Verbinden Sie jedes Lüfter-RGB-Kabel mit dem COMMANDER CORE (Abbildung 3).



Abbildung 1



Abbildung 2

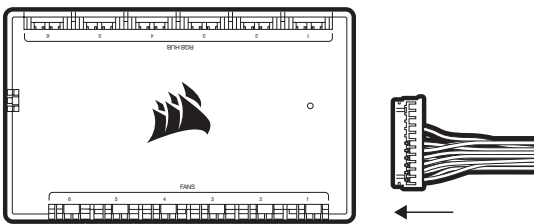

Abbildung 3

COMMANDER CORE UND ELITE LCD XT-MODUL AN USB 2.0-ANSCHLUSS UND STROMVERSORGUNG ANSCHLIESSEN

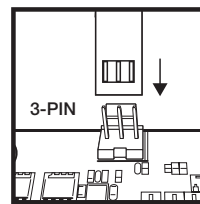
- > Verwenden Sie das mitgelieferte USB-Kabel, um den COMMANDER CORE an einen USB 2.0-Anschluss auf der Hauptplatine anzuschließen.
- > Verbinden Sie das Stromkabel der Pumpe mit einem verfügbaren SATA-Netzstecker Ihres Netzteils.
- > Verwenden Sie den beiliegenden USB-Y-Splitter, um die erforderlichen USB-Anschlüsse von zwei auf einen zu verringern.

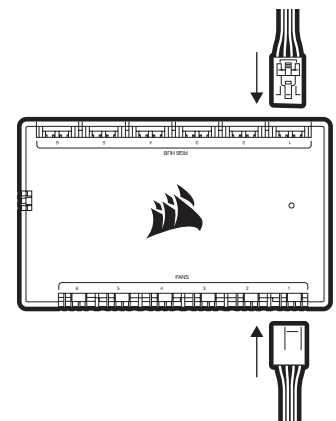
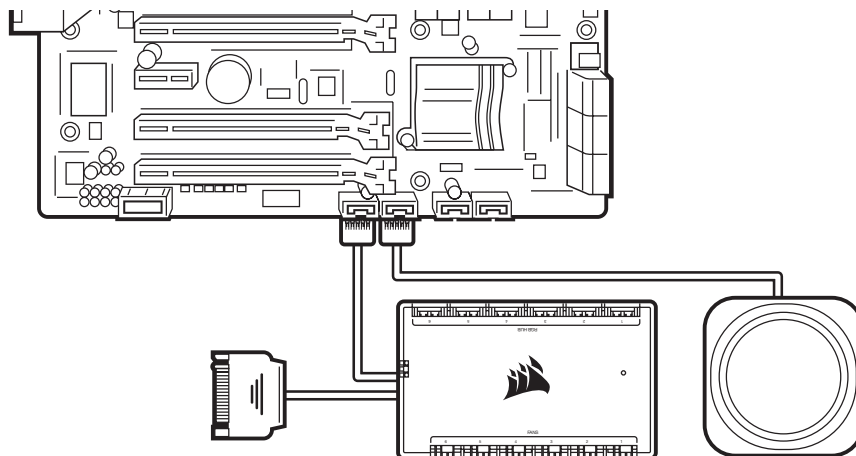

FAQ

1. Wie erkenne ich die Richtung des Luftstroms, der durch den Lüfter erzeugt wird?

Die Richtung des Luftstroms wird durch einen Pfeil auf der Seite des Lüfters signalisiert.

2. Kann ich die auf dem Kühlsystem aufgetragene Wärmeleitpaste bei einer Neuinstallation wiederverwenden?

Bei der Neuinstallation des Kühlsystems muss die aufgetragene Wärmeleitpaste entfernt und die XTM70-Wärmeleitpaste (separat erhältlich) aufgetragen werden.

3. In welcher Ausrichtung sollte ich den Radiator einbauen?

Die beste Art, einen Radiator einzubauen, ist mit den Leitungen an der Unterseite des Gehäuses, obwohl es möglich ist, ihn mit den Leitungen in jeder Position einzubauen, einschließlich in umgekehrter Position, solange der höchste Punkt im Radiator deutlich höher liegt als die CPU-Pumpe.

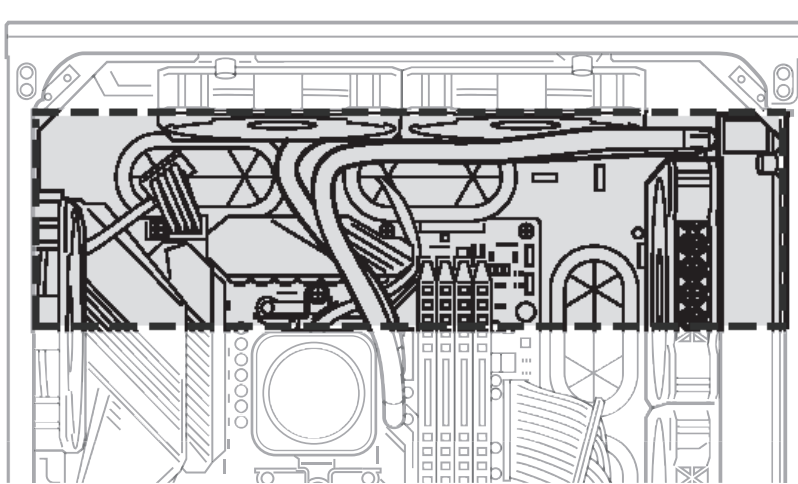
**4. Mein Kühler und meine Lüfter blinken rot oder funktionieren nicht. Wie muss ich vorgehen?**

Prüfen Sie alle Verbindungen des Kühlers und der Lüfter mit dem COMMANDER CORE. Vergewissern Sie sich, dass der COMMANDER Core und das LCD-Modul per iCUE auf die neueste Firmware aktualisiert wurden. Sollte Ihr Problem weiterhin bestehen und Sie zusätzliche Hilfe zur Fehlerbehebung benötigen, öffnen Sie bitte ein Ticket unter support.corsair.com oder wenden Sie sich an unseren Kundenservice.

<https://help.corsair.com/hc/en-us/requests/new>

5. Was kann ich tun, wenn die Backplate des Kühlers nach der Installation locker zu sitzen scheint?

Nach der ersten Montage der Kühler-Backplate auf der Hauptplatine ist es ganz normal, dass sich diese etwas locker anfühlt. Wenn die Kühlerpumpe eingesetzt und fest angezogen ist, wird die Backplate zur Hauptplatine hingezogen und vom Kühler auf den Sockel aufgedrückt.

WICHTIGER HINWEIS: Verwenden Sie **NIEMALS**, unter keinerlei Umständen, zusätzliche Unterlegscheiben oder Abstandshalter, um den Spielraum der Backplate zu reduzieren. Ansonsten wird der Montageindruck auf das Halterungssystem erhöht, was zu Schäden an Halterungssystem, Hauptplatine oder Sockel führen kann.

Let op: De meeste nieuwere pc-behuizingen zijn uitgevoerd met een CPU-uitsparing die de onderkant van het moederbord toegankelijk maakt. Als dat voor jouw pc niet het geval is, moet je voorafgaand aan de installatie het moederbord uit de behuizing verwijderen. Voor een snelle installatie worden de ELITE LCD XT-koelers geleverd met een op de pomp geïnstalleerde Intel-montagebeugel.

INHOUDSOPGAVE

INTEL (alle sockets)

AMD AM5/AM4

AMD sTRX4

INSTALLATIE



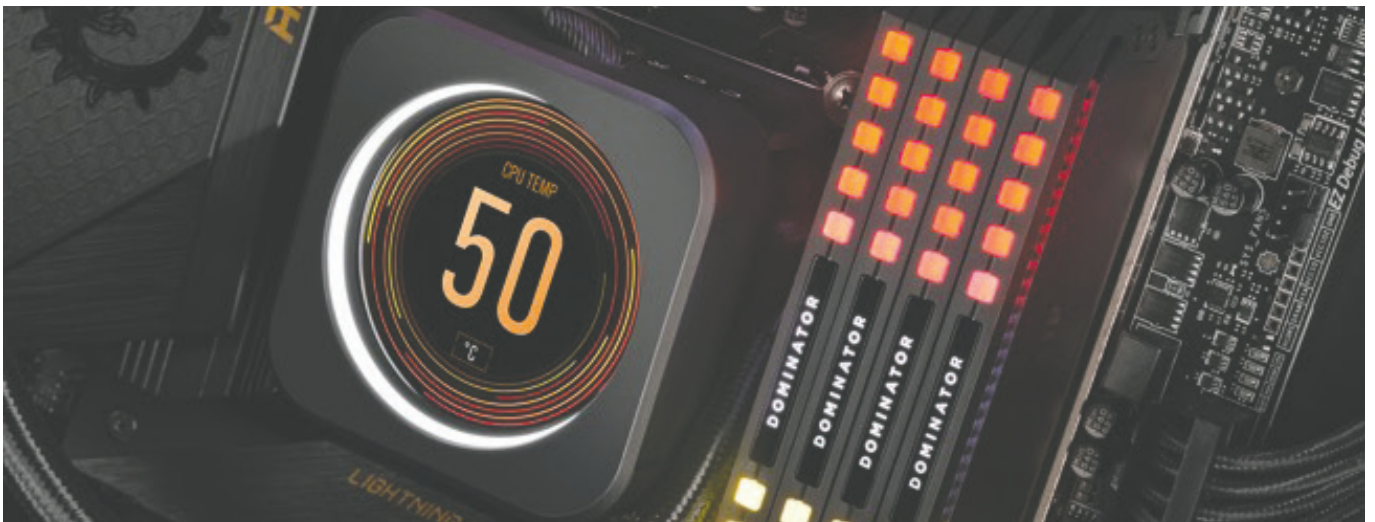





FAQ's

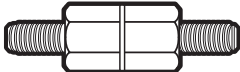
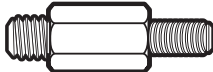

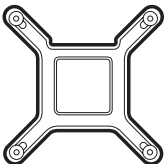
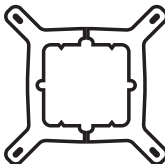
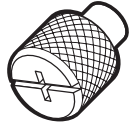
Schakel de pc volledig uit voordat u met de installatie begint. De LCD-module, de pomp en de COMMANDER CORE zijn gevoelig voor hotpluggen en elektrostatiche ontlading.

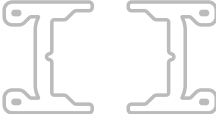
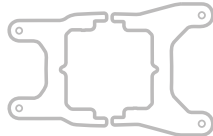
MEEGELEVERDE HARDWARE

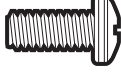
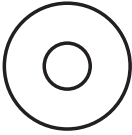
Gemarkeerde tekst heeft alleen betrekking op Intel-installatie

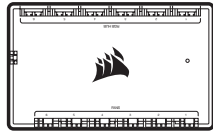
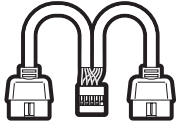
<p>A</p>  <p>x4 INTEL 1200/1150/1151/1156/1155 -AFSTANDHOUDERS</p>	<p>B</p>  <p>x4 INTEL 2011/2011-3/2066 -AFSTANDHOUDERS</p>	<p>C</p>  <p>x4 INTEL 1700-AFSTANDHOUDERS</p>
<p>D</p>  <p>x1 INTEL-ACHTERPLA×AT</p>	<p>E</p>  <p>x1 INTEL-MONTAGEBEUGEL (VOORAF GEÏNSTALLEERD)</p>	<p>F</p>  <p>x4 KARTELSCHROEVEN</p>
<p>G</p>  <p>x4 AMD AM5/AM4-AFSTANDHOUDERS</p>	<p>H</p>  <p>x1 AMD AM5/AM4-MONTAGEBEUGEL</p>	<p>I</p>  <p>x1 AMD sTR4/sTRX4-MONTAGEBEUGEL</p>
<p>J</p>  <p>x4 AMD sTR4/sTRX4-AFSTANDHOUDERS</p>	<p>K</p>  <p>x16 LANGE FANSCHROEVEN (H100i) x24 LANGE FANSCHROEVEN (H150i/H170i)</p>	<p>L</p>  <p>x8 RADIATORSCHROEVEN (H100i) x12 RADIATORSCHROEVEN (H150i/H170i)</p>
<p>M</p>  <p>x8 SLUITRINGEN (H100i) x12 SLUITRINGEN (H150i/H170i)</p>	<p>N</p>  <p>x2 AF RGB ELITE-FANS (H100i) x3 AF RGB ELITE-FANS (H150i/H170i)</p>	<p>O</p>  <p>COMMANDER CORE</p>
<p>P</p>  <p>USB Y-SPLITTER</p>		

1. INSTALLATIE VAN DE INTEL-ACHTERPLAAT

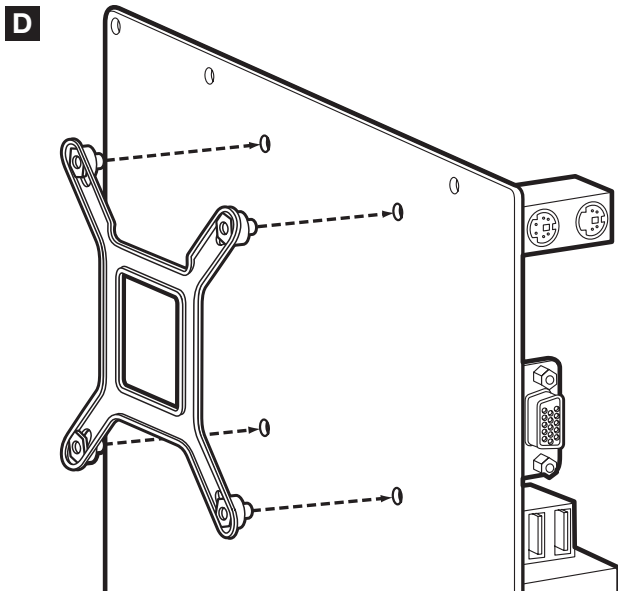

Pas de achterplaat aan op de gewenste socket.

Let op: Voor de Intel LGA 2011/2011-3/2066 hoeft geen achterplaat te worden geïnstalleerd. Ga door naar stap 2.

2. INSTALLATIE VAN DE INTEL-AFSTANDSCHROEVEN

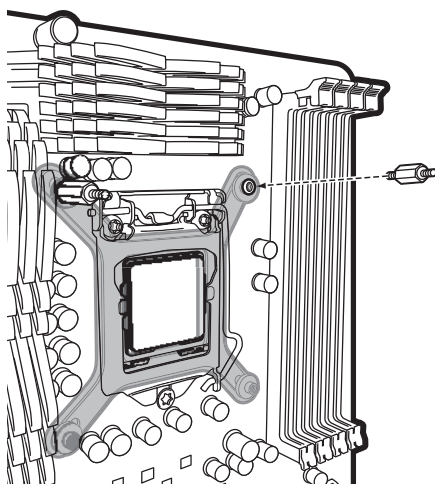

A LGA 1200/1150/
1151/1155/1156

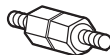

B LGA 2011/
2011-3/2066

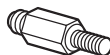

C LGA 1700

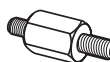

- > Bevestig de meegeleverde Intel-afstandschroeven voor jouw socket.
- > Gebruik (A) voor LGA 1200/115X, (B) voor LGA 2011/2011-3/2066 of (C) voor LGA 1700.
- > Draai alle vier de schroeven stevig aan totdat ze goed vastzitten.

3. INSTALLATIE VAN DE FANS EN RADIATOR

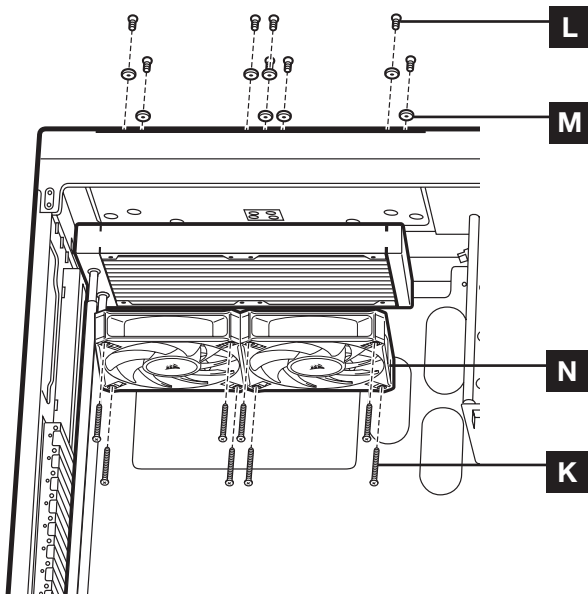

Bevestig de radiator en de fans zoals getoond. Voor de beste koelprestaties raden we je aan de fans als een luchtinlaat op de pc-behuizing te monteren.

4. INSTALLATIE VAN DE POMPUNIT

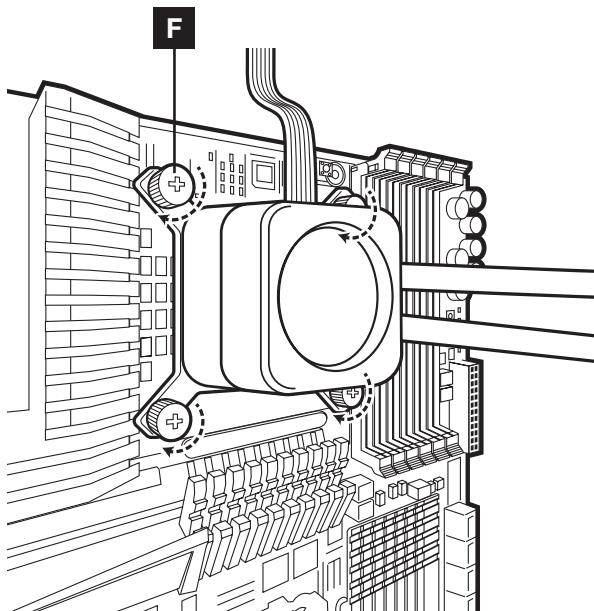







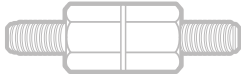

- > Lijn de beugel en de pomp uit over de afstandschroeven, zoals getoond.
- > Bevestig de kartelschroeven (F) op de afstandschroeven, zoals getoond.
- > Draai de kartelschroeven aan totdat alle vier de hoeken stevig vastzitten.

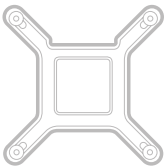
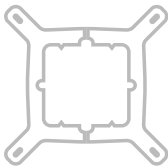
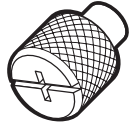
Ga naar pagina 10 om door te gaan met de installatie.

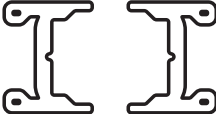
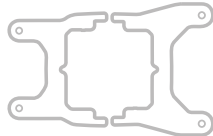
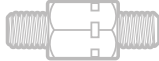
MEEGELEVERDE HARDWARE

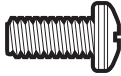
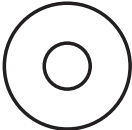
Gemarkeerde tekst heeft alleen betrekking op AMD AM5/AM4-installatie

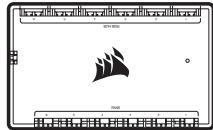
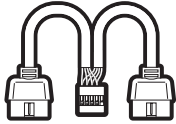
<p>A</p>  <p>x4 INTEL 1200/1150/1151/1156/1155 -AFSTANDHOUDERS</p>	<p>B</p>  <p>x4 INTEL 2011/2011-3/2066 -AFSTANDHOUDERS</p>	<p>C</p>  <p>x4 INTEL 1700-AFSTANDHOUDERS</p>
<p>D</p>  <p>x1 INTEL-ACHTERPLA×AT</p>	<p>E</p>  <p>x1 INTEL-MONTAGEBEUGEL (VOORAF GEÏNSTALLEERD)</p>	<p>F</p>  <p>x4 KARTELSCHROEVEN</p>
<p>G</p>  <p>x4 AMD AM5/AM4-AFSTANDHOUDERS</p>	<p>H</p>  <p>x1 AMD AM5/AM4-MONTAGEBEUGEL</p>	<p>I</p>  <p>x1 AMD sTR4/sTRX4-MONTAGEBEUGEL</p>
<p>J</p>  <p>x4 AMD sTR4/sTRX4-AFSTANDHOUDERS</p>	<p>K</p>  <p>x16 LANGE FANSCHROEVEN (H100i) x24 LANGE FANSCHROEVEN (H150i/H170i)</p>	<p>L</p>  <p>x8 RADIATORSCHROEVEN (H100i) x12 RADIATORSCHROEVEN (H150i/H170i)</p>
<p>M</p>  <p>x8 SLUITRINGEN (H100i) x12 SLUITRINGEN (H150i/H170i)</p>	<p>N</p>  <p>x2 AF RGB ELITE-FANS (H100i) x3 AF RGB ELITE-FANS (H150i/H170i)</p>	<p>O</p>  <p>COMMANDER CORE</p>
<p>P</p>  <p>USB Y-SPLITTER</p>		

1. INSTALLATIE VAN DE AMD AM5/AM4-MONTAGEBEUGEL

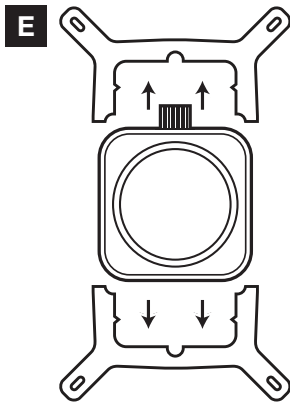

Afbeelding 1

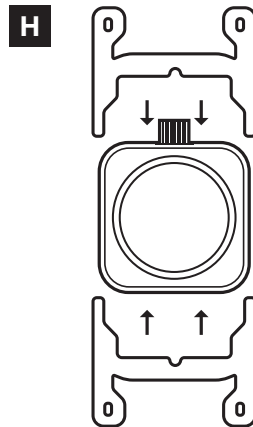

Afbeelding 2

- > Verwijder de geïntegreerde Intel-montagebeugel (afbeelding 1).
- > Plaats de AMD AM5/AM4-beugel door beide zijden in de sleuf op de pomp te duwen totdat de beugel stevig vastzit (afbeelding 2).

Let op: Het is belangrijk dat de AMD AM5/AM4-retentiebeugel aan alle zijden gelijkmatig vastzit voordat met de installatie wordt begonnen!

2. INSTALLATIE VAN DE FANS EN RADIATOR

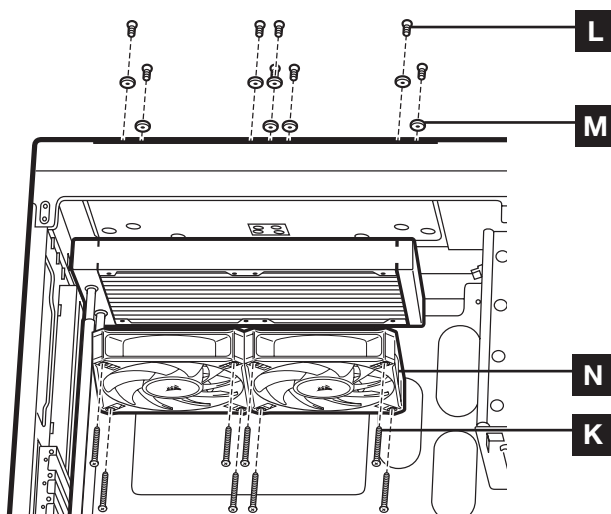

Bevestig de radiator en de fans zoals getoond. Voor de beste koelprestaties raden we je aan de fans als een luchtinlaat op de pc-behuizing te monteren.

3. HET MOEDERBORD VOORBEREIDEN VOOR INSTALLATIE

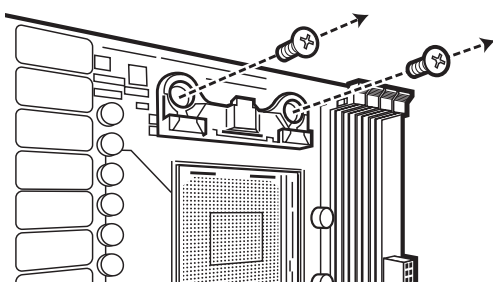

Verwijder de bevestigde AMD AM5/AM4-montagebeugels, zoals getoond.

4. INSTALLATIE VAN DE AMD AM5/AM4-AFSTANDSCHROEVEN

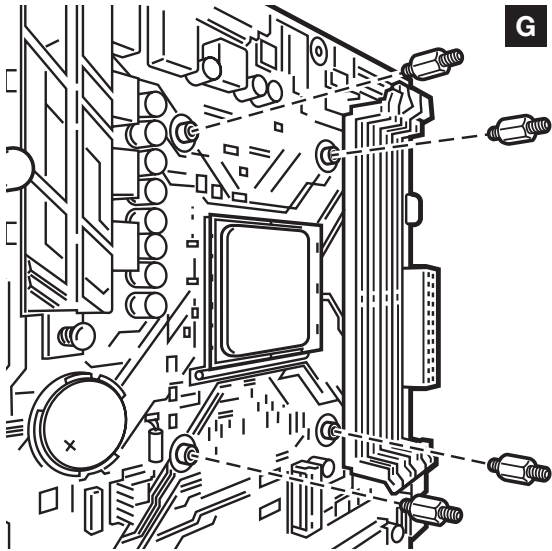

- > Bevestig de meegeleverde AMD AM5/AM4-afstandschroeven in de CPU-socket.
- > Draai alle vier de schroeven stevig aan totdat ze goed vastzitten.

5. INSTALLATIE VAN DE POMPUNIT

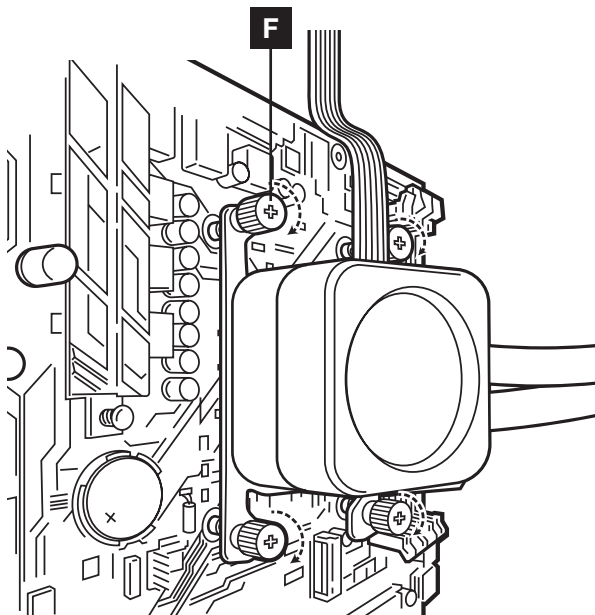







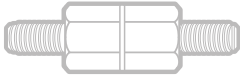

- Lijn de beugel uit de met de AMD AM5/AM4-afstandhouders, zoals getoond.
- Draai de kartelschroeven (F) stevig vast.

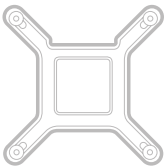
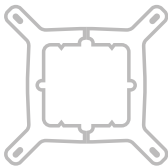
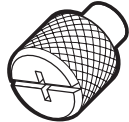
Ga naar pagina 10 om door te gaan met de installatie.

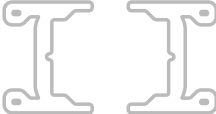
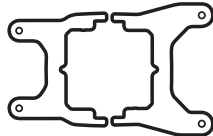
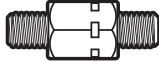
MEEGELEVERDE HARDWARE

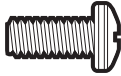
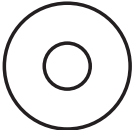
Gemarkeerde tekst heeft alleen betrekking op AMD sTRX4-installatie

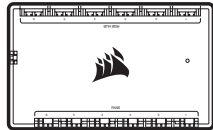
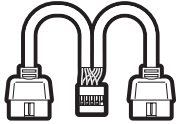
<p>A</p>  <p>x4 INTEL 1200/1150/1151/1156/1155 -AFSTANDHOUDERS</p>	<p>B</p>  <p>x4 INTEL 2011/2011-3/2066 -AFSTANDHOUDERS</p>	<p>C</p>  <p>x4 INTEL 1700-AFSTANDHOUDERS</p>
<p>D</p>  <p>x1 INTEL-ACHTERPLA×AT</p>	<p>E</p>  <p>x1 INTEL-MONTAGEBEUGEL (VOORAF GEÏNSTALLEERD)</p>	<p>F</p>  <p>x4 KARTELSCHROEVEN</p>
<p>G</p>  <p>x4 AMD AM5/AM4-AFSTANDHOUDERS</p>	<p>H</p>  <p>x1 AMD AM5/AM4-MONTAGEBEUGEL</p>	<p>I</p>  <p>x1 AMD sTR4/sTRX4-MONTAGEBEUGEL</p>
<p>J</p>  <p>x4 AMD sTR4/sTRX4-AFSTANDHOUDERS</p>	<p>K</p>  <p>x16 LANGE FANSCHROEVEN (H100i) x24 LANGE FANSCHROEVEN (H150i/H170i)</p>	<p>L</p>  <p>x8 RADIATORSCHROEVEN (H100i) x12 RADIATORSCHROEVEN (H150i/H170i)</p>
<p>M</p>  <p>x8 SLUITRINGEN (H100i) x12 SLUITRINGEN (H150i/H170i)</p>	<p>N</p>  <p>x2 AF RGB ELITE-FANS (H100i) x3 AF RGB ELITE-FANS (H150i/H170i)</p>	<p>O</p>  <p>COMMANDER CORE</p>
<p>P</p>  <p>USB Y-SPLITTER</p>		

1. INSTALLATIE VAN DE AMD sTRX4-MONTAGEBEUGEL

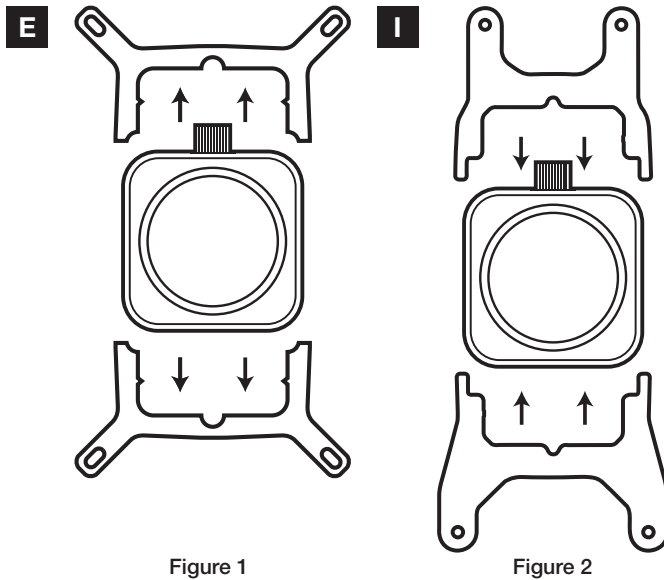

- > Verwijder de geïntegreerde Intel-montagebeugel (afbeelding 1).
- > Plaats de AMD sTRX4-beugel door beide zijden in de sleuf op de pompte duwen totdat de beugel stevig vastzit (afbeelding 2).

Let op: Het is belangrijk dat de AMD sTRX4-retentiebeugel aan alle zijden gelijkmatig vastzit voordat met de installatie wordt begonnen!

2. INSTALLATIE VAN DE AMD sTRX4-AFSTANDSCHROEVEN

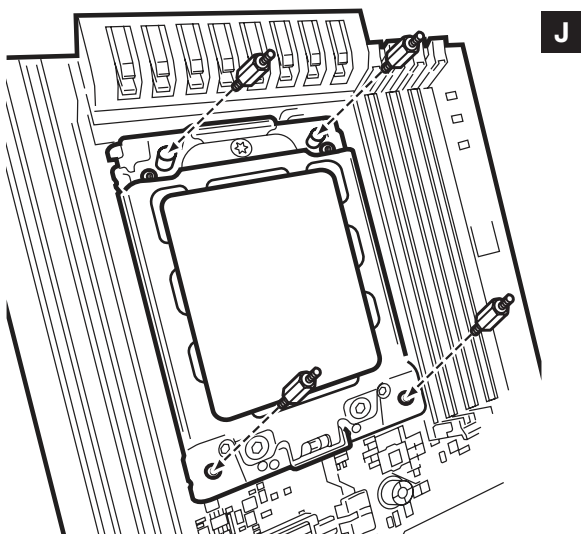

- > Bevestig de meegeleverde AMD sTRX4-afstandschroeven in de CPU-socket.
- > Draai alle vier de schroeven stevig aan totdat ze goed vastzitten.

3. INSTALLATIE VAN DE FANS EN RADIATOR

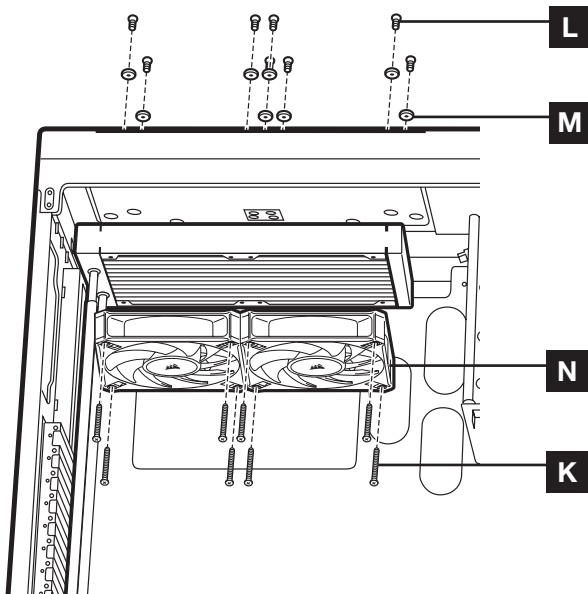

Bevestig de radiator en de fans zoals getoond. Voor de beste koelprestaties raden we je aan de fans als een luchtinlaat op de pc-behuizing te monteren.

4. INSTALLATIE VAN DE POMPUNIT

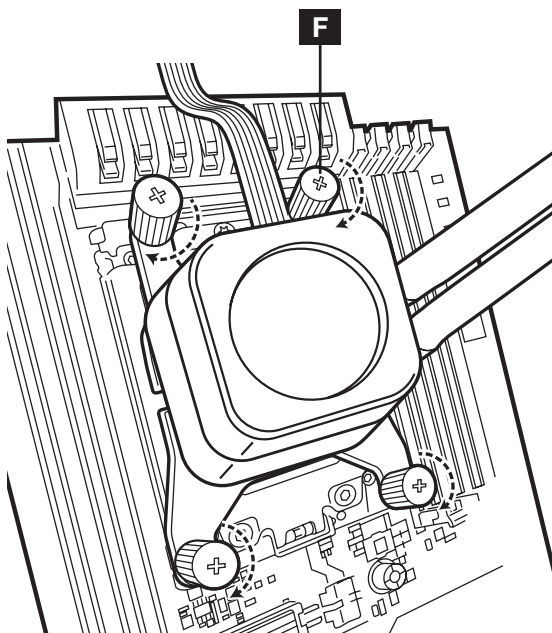

- > Lijn de beugel en de pomp uit over de afstandschroeven, zoals getoond.
- > Bevestig de kartelschroeven (F) op de afstandschroeven, zoals getoond.
- > Draai de kartelschroeven aan totdat alle vier de hoeken stevig vastzitten.

Ga naar pagina 10 om door te gaan met de installatie.

AANSLUITEN VAN DE FANS EN POMP OP DE COMMANDER CORE

- > Sluit de 24-pins kabel van de pomp aan op de COMMANDER CORE (afbeelding 1).
- > Sluit de tach-kabel van de pomp aan op de CPU_FAN-header op het moederbord (afbeelding 2).
- > Sluit elke fan aan op de COMMANDER CORE (afbeelding 3).
- > Sluit de RGB-lead van elke fan aan op de COMMANDER CORE (afbeelding 3).

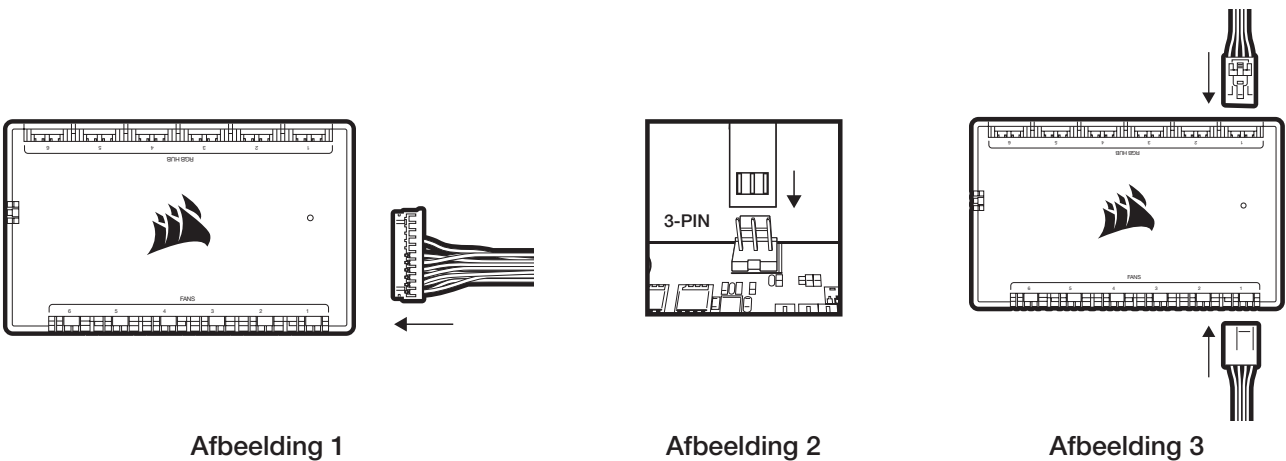

AANSLUITEN VAN DE COMMANDER CORE EN ELITE LCD XT-MODULE OP DE USB 2.0-HEADER EN VOEDING

- > Gebruik de meegeleverde USB-kabel om de COMMANDER CORE aan te sluiten op een USB 2.0-header op het moederbord.
- > Sluit de voedingskabel van de pomp aan op een beschikbare SATA-stroomplug.
- > Gebruik de meegeleverde USB Y-splitter om het benodigde aantal USB-poorten terug te brengen van twee naar één.

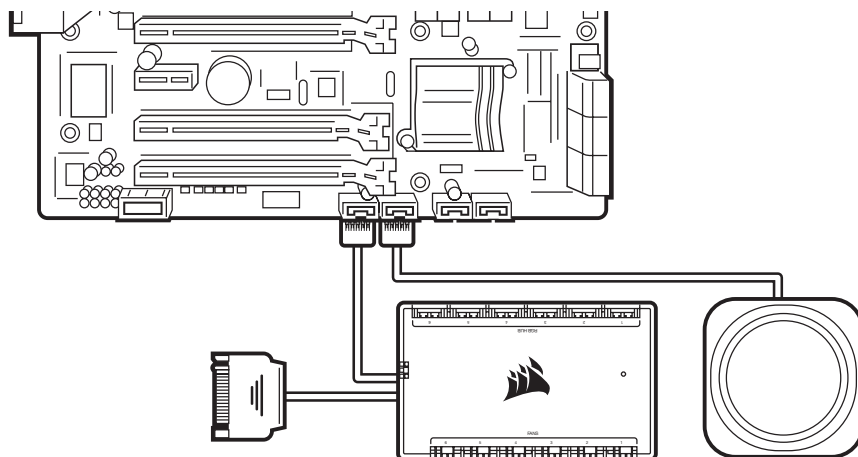

FAQ's

1. Hoe kan ik zien in welke richting de luchtstroom van de fan staat?

Een pijl op de zijkant van de fan geeft de richting van de luchtstroom aan.

2. Kan ik de reeds aanwezige koelpasta op de koeler opnieuw gebruiken bij een volgende installatie?

Als je de koeler opnieuw wilt installeren, moet je de reeds aanwezige koelpasta verwijderen en de XTM70-koelpasta opnieuw aanbrengen (afzonderlijk verkrijgbaar).

3. In welke richting moet ik mijn radiator installeren?

Je kunt een radiator het beste installeren met de buizen op de bodem van de behuizing, al kun je de buizen in elke positie plaatsen. Je kunt de radiator ook verticaal plaatsen, zolang het hoogste punt van de radiator zichtbaar hoger is dan de CPU-pomp.

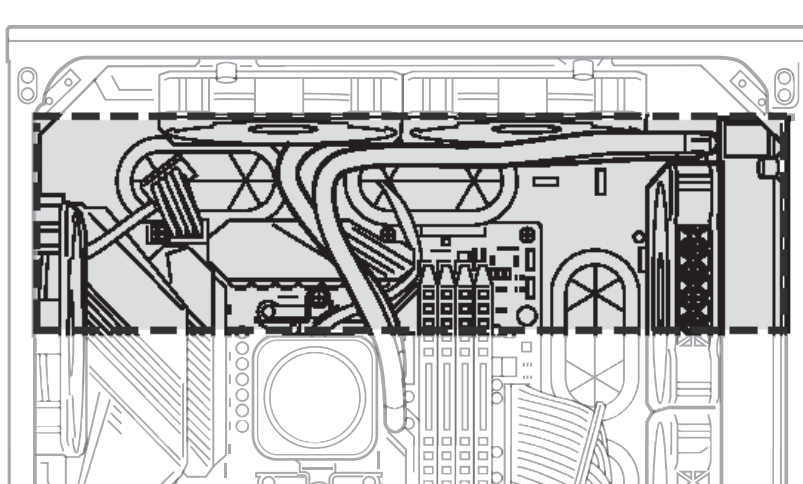

4. Mijn koeler en fans knipperen rood of werken niet. Wat moet ik doen?

Controleer alle aansluitingen van de koeler en de fans naar de COMMANDER CORE. Zorg ervoor dat de COMMANDER CORE en de LCD-module via iCUE zijn bijgewerkt met de meest recente firmware. Als dit het probleem niet oplost, open dan een ticket op support.corsair.com of neem contact op met onze klantenservice voor verdere probleemoplossing en hulp.

<https://help.corsair.com/hc/en-us/requests/new>

5. Wat moet ik doen als de achterplaat van de koeler na installatie los aanvoelt?

Het is normaal dat de achterplaat van de koeler los aanvoelt nadat deze voor het eerst op het moederbord is geïnstalleerd. Nadat de koelerpomp is geplaatst en vastgedraaid, trekt deze de achterplaat naar het moederbord en wordt er via de koeler druk uitgeoefend op de socket.

BELANGRIJK: Gebruik in geen geval extra ringen en afstandsringsen om de speling in de achterplaat te verminderen. Wanneer deze worden gebruikt, neemt de montagedruk op de retentiekits toe, wat tot beschadiging van de retentiekits, het moederbord of de socket kan leiden.

Nota: la maggior parte dei case per PC più recenti include un'apertura dietro la CPU che consente l'accesso alla parte inferiore della scheda madre. Se il case non include tale apertura, sarà necessario rimuovere se il case non include un'apertura, occorrerà rimuovere la scheda madre dal case prima di procedere con l'installazione. I dissipatori ELITE LCD XT sono dotati di staffa di montaggio Intel preinstallata sulla pompa per un'installazione rapida.

SOMMARIO

INTEL (tutti i socket)

AMD AM5/AM4

AMD sTRX4

INSTALLAZIONE



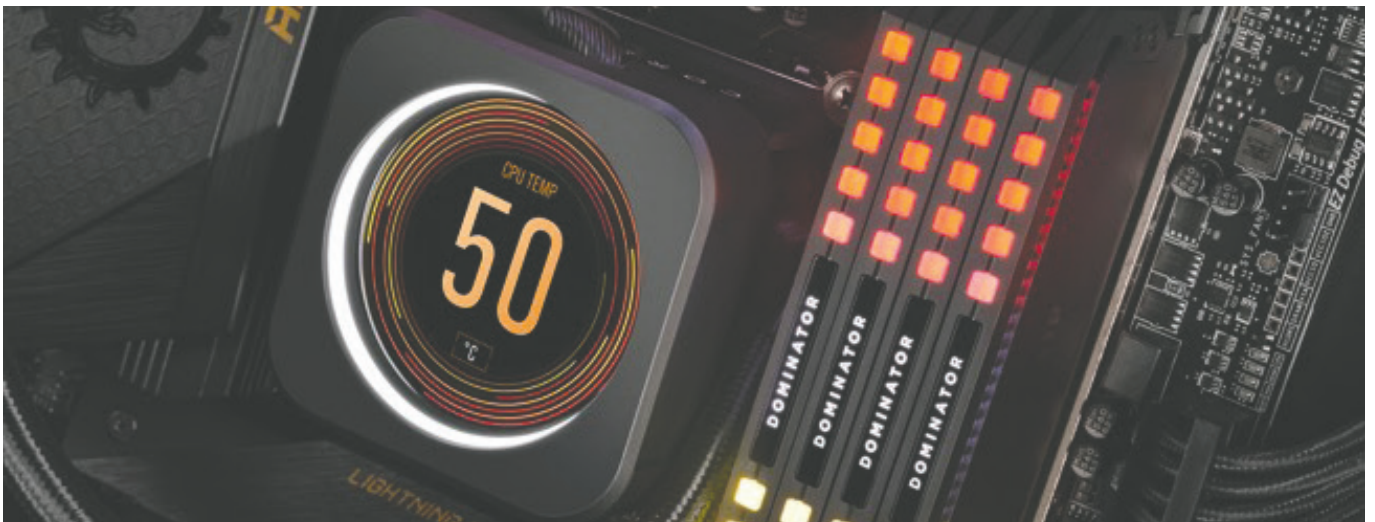





DOMANDE FREQUENTI

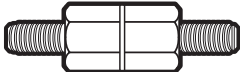
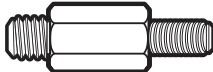

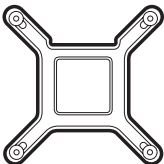
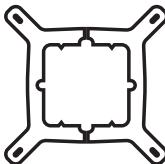
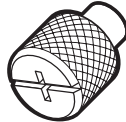
Assicurati che il PC sia spento prima di procedere all'installazione. Il modulo LCD, la pompa e il COMMANDER CORE sono sensibili ai collegamenti a caldo e alle scariche elettrostatiche.

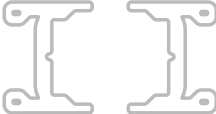
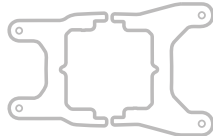
ACCESSORI HARDWARE INCLUSI

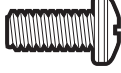
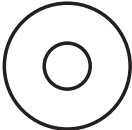
Gli accessori evidenziati sono esclusivamente per l'installazione della staffa Intel

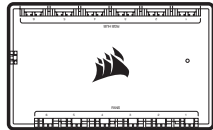
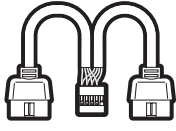
<p>A</p>  <p>x4 DISTANZIATORI INTEL 1200/1150/1151/1156/1155</p>	<p>B</p>  <p>x4 DISTANZIATORI INTEL 2011/2011-3/2066</p>	<p>C</p>  <p>x4 DISTANZIATORI INTEL 1700</p>
<p>D</p>  <p>x1 PIASTRA POSTERIORE INTEL</p>	<p>E</p>  <p>x1 STAFFA DI MONTAGGIO INTEL (PRE-INSTALLATA)</p>	<p>F</p>  <p>x4 VITI A GALLETTO</p>
<p>G</p>  <p>x4 DISTANZIATORI AMD AM5/AM4</p>	<p>H</p>  <p>x1 STAFFA DI MONTAGGIO AMD AM5/AM4</p>	<p>I</p>  <p>x1 STAFFA DI MONTAGGIO AMD STR4/STRX4</p>
<p>J</p>  <p>x4 DISTANZIATORI AMD sTR4/sTRX4</p>	<p>K</p>  <p>x16 VITI LUNGHE PER VENTOLA (H100i) x24 VITI LUNGHE PER VENTOLA (H150i/H170i)</p>	<p>L</p>  <p>x8 VITI PER RADIATORE (H100i) x12 VITI PER RADIATORE (H150i/H170i)</p>
<p>M</p>  <p>x8 RONDELLE (H100i) x12 RONDELLE (H150i/H170i)</p>	<p>N</p>  <p>x2 VENTOLE AF RGB ELITE (H100i) x3 VENTOLE AF RGB ELITE (H150i/H170i)</p>	<p>O</p>  <p>COMMANDER CORE</p>
<p>P</p>  <p>CAVO SDOPPIATORE USB A Y</p>		

1. INSTALLAZIONE DELLA PIASTRA POSTERIORE INTEL

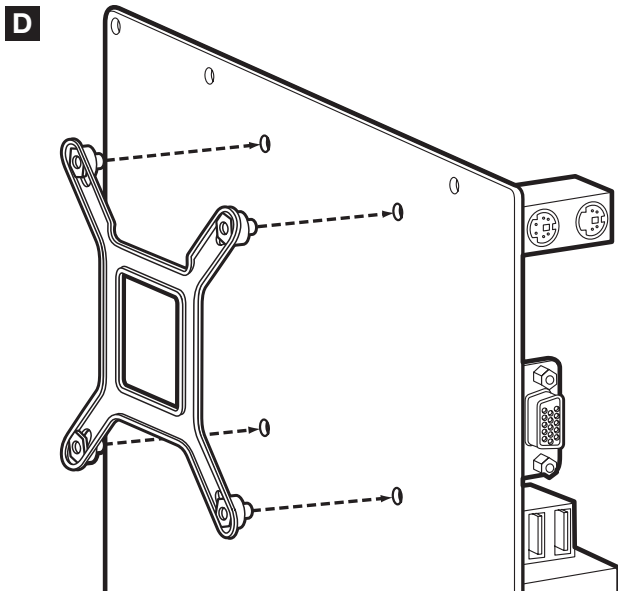

Regolare la piastra posteriore in base al socket da installare.

Nota: Intel LGA 2011/2011-3/2066 non necessitano di una piastra posteriore. Andare al passaggio 2.

2. INSTALLAZIONE DELLE VITI DEL SUPPORTO INTEL

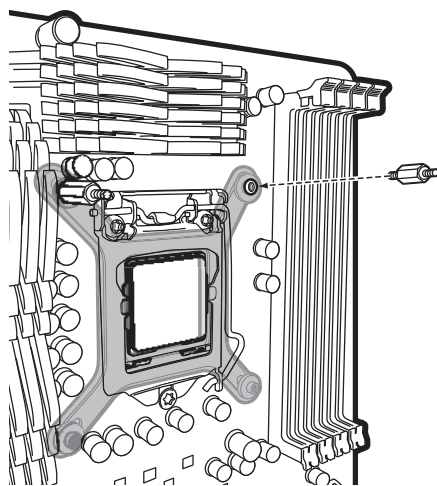

A LGA 1200/1150/
1151/1155/1156

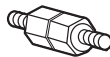

B LGA 2011/
2011-3/2066

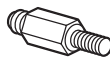

C LGA 1700

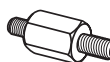

- > Fissare il supporto Intel fornito per il socket.
- > Usare (A) per LGA 1200/115X, (B) per LGA 2011/2011-3/2066 o (C) per LGA 1700.
- > Stringere saldamente tutte e quattro le viti.

3. INSTALLARE LE VENTOLE E IL RADIATORE

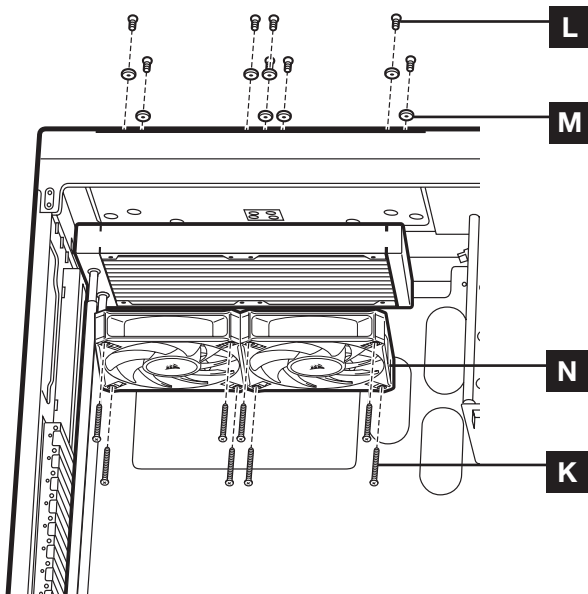

Collegare il radiatore e le ventole come illustrato. Per ottenere le prestazioni di raffreddamento migliori, si consiglia di montare le ventole in modo che aspirino aria all'interno del PC.

4. INSTALLAZIONE DELL'UNITÀ DI POMPAGGIO

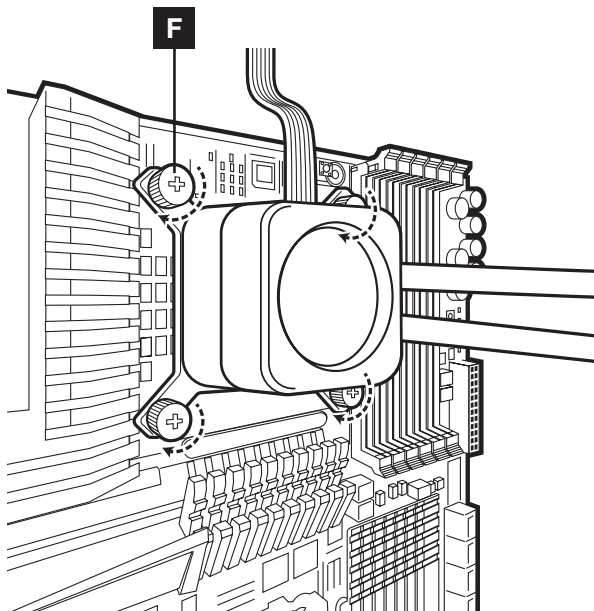









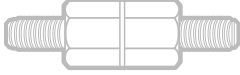

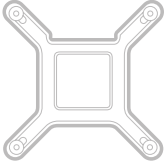
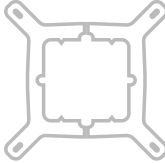
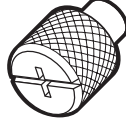
- > Allineare la staffa e la pompa con le viti del supporto come illustrato.
- > Fissare le viti a galletto (F) sui distanziatori come illustrato nell'immagine.
- > Stringere saldamente le viti a galletto (F) su tutti e quattro gli angoli.

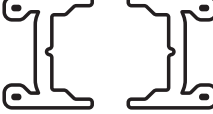
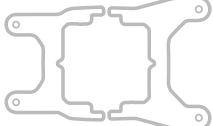
Per continuare l'installazione, passare a pagina 10.

ACCESSORI HARDWARE INCLUSI

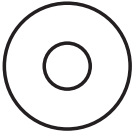
Gli accessori evidenziati sono esclusivamente per l'installazione della staffa AMD AM5/AM4

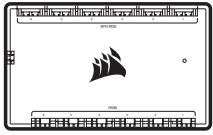
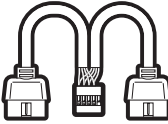
<p>A</p>  <p>x4 DISTANZIATORI INTEL 1200/1150/1151/1156/1155</p>	<p>B</p>  <p>x4 DISTANZIATORI INTEL 2011/2011-3/2066</p>	<p>C</p>  <p>x4 DISTANZIATORI INTEL 1700</p>
<p>D</p>  <p>x1 PIASTRA POSTERIORE INTEL</p>	<p>E</p>  <p>x1 STAFFA DI MONTAGGIO INTEL (PRE-INSTALLATA)</p>	<p>F</p>  <p>x4 VITI A GALLETTO</p>
<p>G</p>  <p>x4 DISTANZIATORI AMD AM5/AM4</p>	<p>H</p>  <p>x1 STAFFA DI MONTAGGIO AMD AM5/AM4</p>	<p>I</p>  <p>x1 STAFFA DI MONTAGGIO AMD STR4/STRX4</p>
<p>J</p>  <p>x4 DISTANZIATORI AMD sTR4/sTRX4</p>	<p>K</p>  <p>x16 VITI LUNGHE PER VENTOLA (H100i) x24 VITI LUNGHE PER VENTOLA (H150i/H170i)</p>	<p>L</p>  <p>x8 VITI PER RADIATORE (H100i) x12 VITI PER RADIATORE (H150i/H170i)</p>
<p>M</p>  <p>x8 RONDELLE (H100i) x12 RONDELLE (H150i/H170i)</p>	<p>N</p>  <p>x2 VENTOLE AF RGB ELITE (H100i) x3 VENTOLE AF RGB ELITE (H150i/H170i)</p>	<p>O</p>  <p>COMMANDER CORE</p>
<p>P</p>  <p>CAVO SDOPPIATORE USB A Y</p>		

1. INSTALLAZIONE DELLA STAFFA DI MONTAGGIO AMD AM5/AM4



Figura 1



Figura 2

- > Rimuovere la staffa di montaggio Intel integrata (figura 1).
- > Installare la staffa AMD AM5/AM4 spingendo entrambe le estremità nell'apposito alloggiamento sulla pompa fino a bloccarla (figura 2).

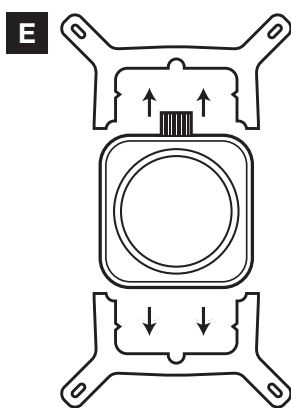
Nota: È importante che la staffa di bloccaggio AMD AM5/AM4 sia fissata in modo uniforme su tutti i lati prima dell'installazione.

2. INSTALLARE LE VENTOLE E IL RADIATORE

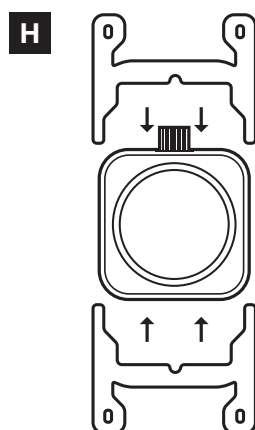
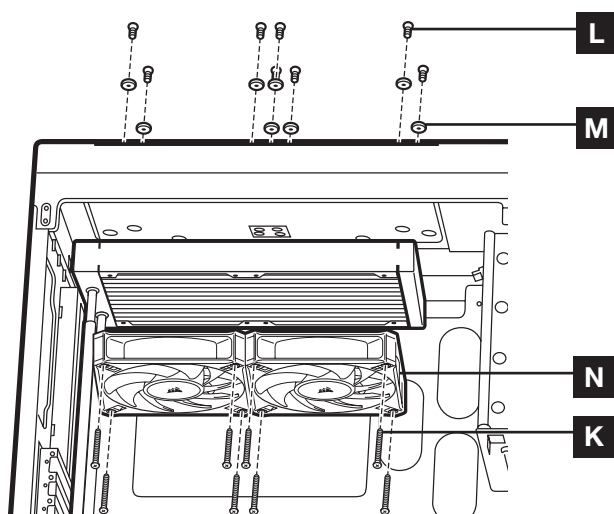

Collegare il radiatore e le ventole come illustrato. Per ottenere le prestazioni di raffreddamento migliori, si consiglia di montare le ventole in modo che aspirino aria all'interno del PC.

3. PREPARAZIONE DELLA SCHEDA MADRE PER L'INSTALLAZIONE

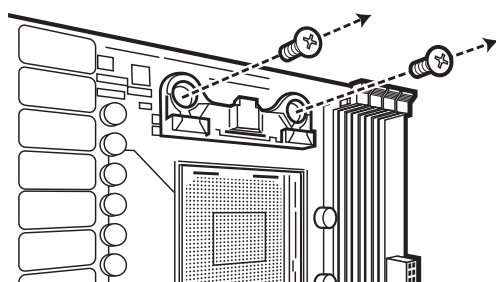

Rimuovere le staffe di montaggio per AMD AM5/AM4 come mostrato nell'immagine.

4. INSTALLAZIONE DELLE VITI DEL SUPPORTO AMD AM5/AM4

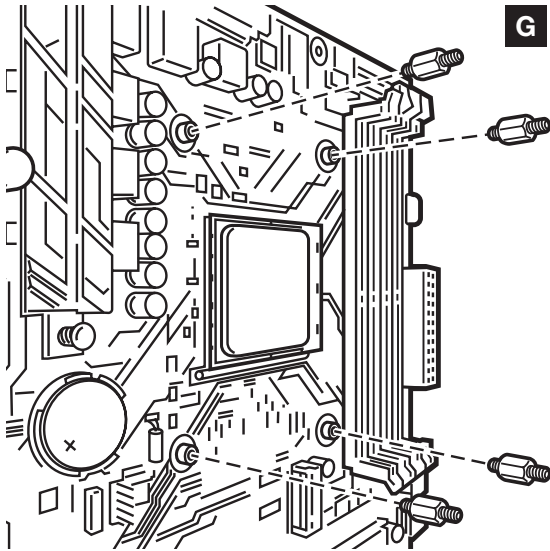

- > Fissare i supporti AMD AM5/AM4 forniti al socket della CPU.
- > Stringere saldamente tutte e quattro le viti.

5. INSTALLAZIONE DELL'UNITÀ DI POMPAGGIO

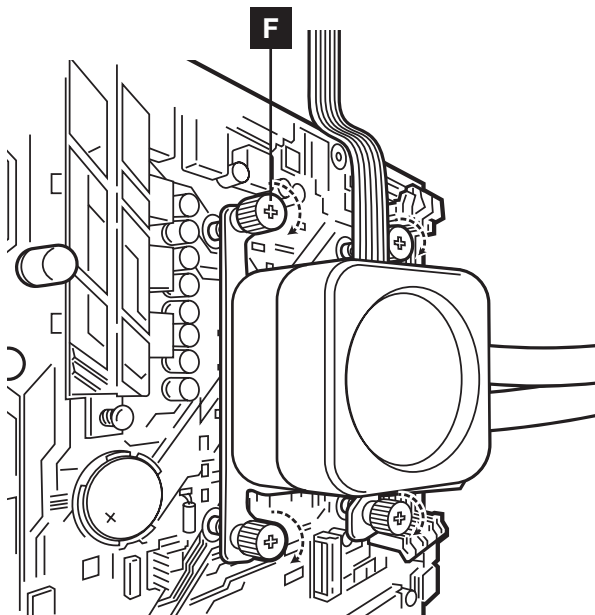







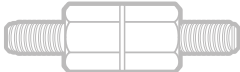
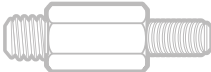

Allineare la staffa ai distanziatori AMD AM5/AM4 come illustrato nell'immagine. Stringere saldamente le viti a galletto (F).

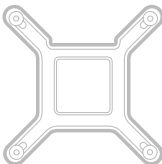
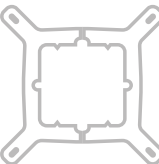
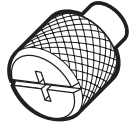
Per continuare l'installazione, passare a pagina 10.

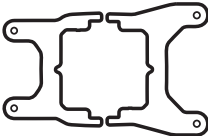
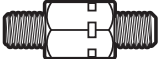
ACCESSORI HARDWARE INCLUSI

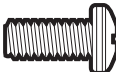
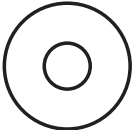
Gli accessori evidenziati sono esclusivamente per l'installazione della staffa AMD sTRX4

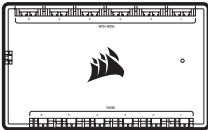
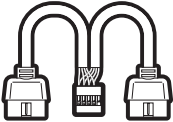
<p>A</p>  <p>x4 DISTANZIATORI INTEL 1200/1150/1151/1156/1155</p>	<p>B</p>  <p>x4 DISTANZIATORI INTEL 2011/2011-3/2066</p>	<p>C</p>  <p>x4 DISTANZIATORI INTEL 1700</p>
<p>D</p>  <p>x1 PIASTRA POSTERIORE INTEL</p>	<p>E</p>  <p>x1 STAFFA DI MONTAGGIO INTEL (PRE-INSTALLATA)</p>	<p>F</p>  <p>x4 VITI A GALLETTO</p>
<p>G</p>  <p>x4 DISTANZIATORI AMD AM5/AM4</p>	<p>H</p>  <p>x1 STAFFA DI MONTAGGIO AMD AM5/AM4</p>	<p>I</p>  <p>x1 STAFFA DI MONTAGGIO AMD STR4/STRX4</p>
<p>J</p>  <p>x4 DISTANZIATORI AMD sTR4/STRX4</p>	<p>K</p>  <p>x16 VITI LUNGHE PER VENTOLA (H100i) x24 VITI LUNGHE PER VENTOLA (H150i/H170i)</p>	<p>L</p>  <p>x8 VITI PER RADIATORE (H100i) x12 VITI PER RADIATORE (H150i/H170i)</p>
<p>M</p>  <p>x8 RONDELLE (H100i) x12 RONDELLE (H150i/H170i)</p>	<p>N</p>  <p>x2 VENTOLE AF RGB ELITE (H100i) x3 VENTOLE AF RGB ELITE (H150i/H170i)</p>	<p>O</p>  <p>COMMANDER CORE</p>
<p>P</p>  <p>CAVO SDOPPIATORE USB A Y</p>		

1. INSTALLAZIONE DELLA STAFFA DI MONTAGGIO AMD sTRX4



Figura 1

Figura 2

- > Rimuovere la staffa di montaggio Intel integrata (figura 1).
- > Installare la staffa AMD sTRX4 spingendo entrambe le estremità nell'apposito alloggiamento sulla pompa fino a bloccarla (figura 2).

Nota: È importante che la staffa di bloccaggio AMD sTRX4 sia fissata in modo uniforme su tutti i lati prima dell'installazione.

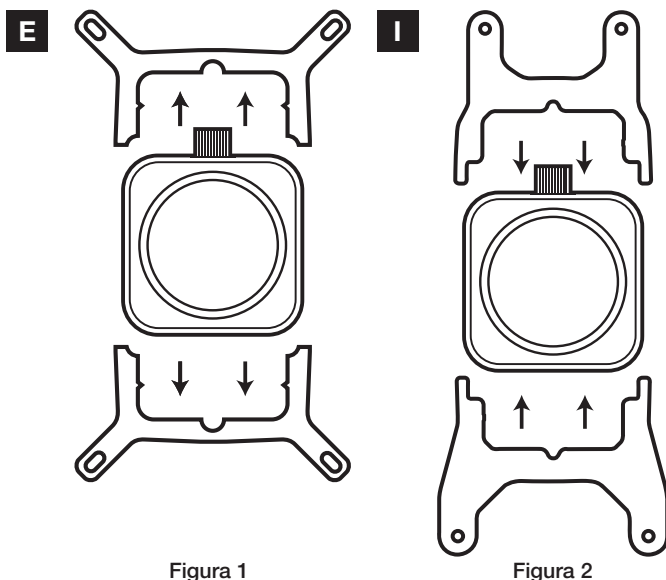
2. INSTALLAZIONE DELLE VITI DEL SUPPORTO AMD sTRX4

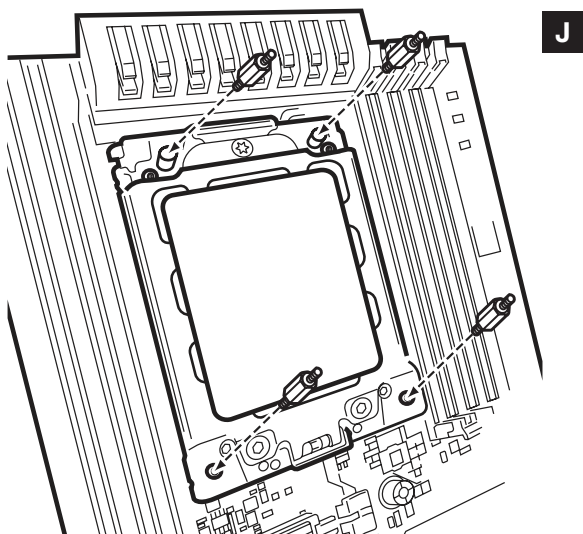

- > Fissare i supporti AMD sTRX4 forniti al socket della CPU.
- > Stringere saldamente tutte e quattro le viti.

3. INSTALLARE LE VENTOLE E IL RADIATORE

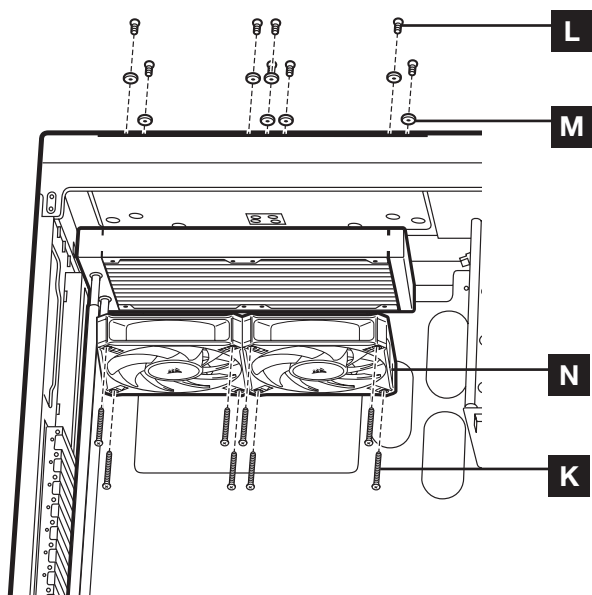

Collegare il radiatore e le ventole come illustrato. Per ottenere le prestazioni di raffreddamento migliori, si consiglia di montare le ventole in modo che aspirino aria all'interno del PC.

4. INSTALLAZIONE DELL'UNITÀ DI POMPAGGIO

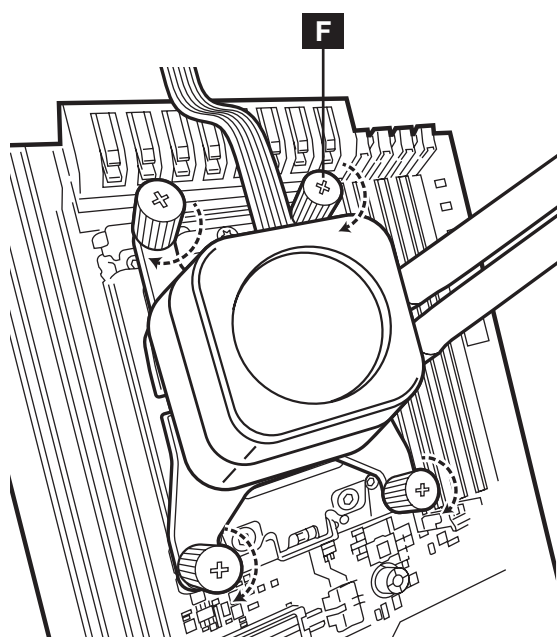

- > Allineare la staffa e la pompa con le viti del supporto come illustrato.
- > Fissare le viti a galletto (F) sui distanziatori come illustrato nell'immagine.
- > Stringere saldamente le viti a galletto (F) su tutti e quattro gli angoli.

Per continuare l'installazione, passare a pagina 10.

COLLEGAMENTO DELLE VENTOLE E DELLA POMPA A COMMANDER CORE

- > Collegare il cavo a 24 pin della pompa a COMMANDER CORE (Figura 1).
- > Collegare il cavo tachimetro della pompa all'header VENTOLA_CPU sulla scheda madre (Figura 2).
- > Collegare ciascuna ventola a COMMANDER CORE (Figura 3).
- > Collegare ciascun terminale della ventola RGB a COMMANDER CORE (figura 3).



Figura 1



Figura 2

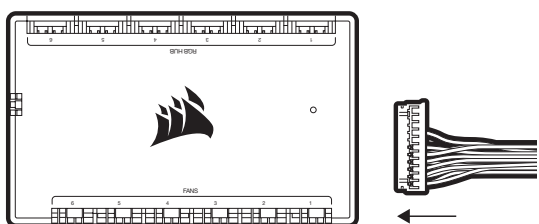

Figura 3

COLLEGAMENTO DI COMMANDER CORE E DEL MODULO ELITE LCD XT ALL'HEADER USB 2.0 E ALL'ALIMENTAZIONE

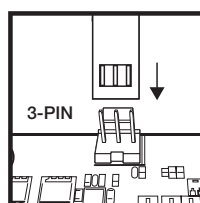
- > Usando il cavo USB incluso, collegare COMMANDER CORE a un header USB 2.0 della scheda madre.
- > Collegare il cavo di alimentazione della pompa a una presa di alimentazione SATA disponibile dell'alimentatore.
- > Utilizzare il cavo sdoppiatore USB a Y in dotazione in modo da utilizzare 1 sola porta USB anziché 2.

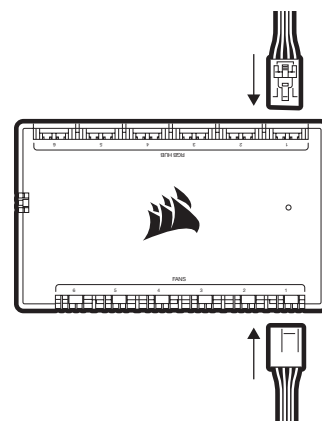
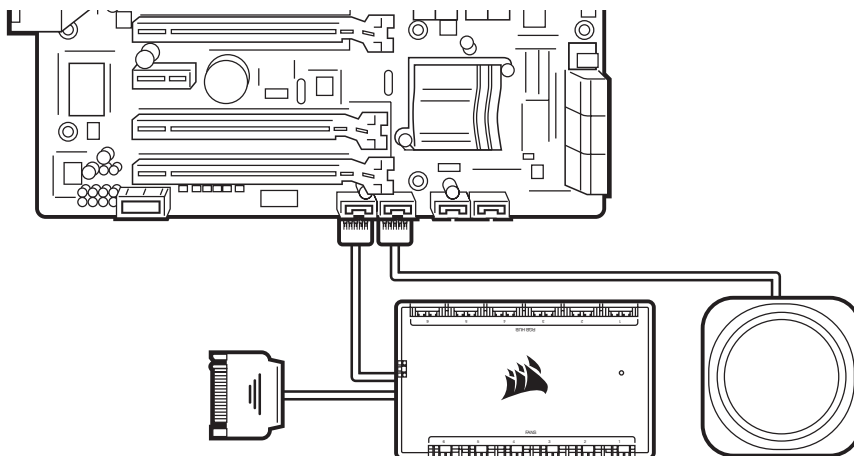

DOMANDE FREQUENTI

1. Come si determina la direzione del flusso d'aria della ventola?

La freccia situata sulla parte laterale della ventola indica la direzione del flusso d'aria.

2. È possibile riutilizzare la pasta termoconduttiva preapplicata sul dissipatore di calore per una seconda installazione?

Per reinstallare il dissipatore di calore è necessario rimuovere la pasta termoconduttiva preapplicata e applicare la pasta termica XTM70 (venduta separatamente).

3. In che modo installare il radiatore?

La soluzione migliore è installare il radiatore con i tubi rivolti verso la parte inferiore del case. Tuttavia, è possibile installarlo posizionando i tubi come si preferisce, ad esempio come un radiatore invertito, purché la parte superiore del radiatore sia visibilmente più alta della pompa sulla CPU.

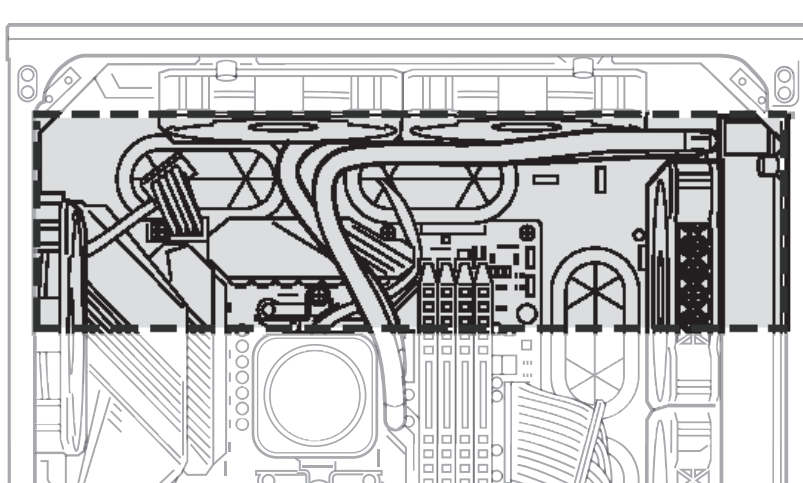

4. Il sistema di raffreddamento e le ventole lampeggiano in rosso o non funzionano. Cosa fare?

Controllare tutte le connessioni del sistema di raffreddamento e delle ventole al COMMANDER CORE. Assicurarsi che il COMMANDER CORE e il modulo LCD siano aggiornati al firmware più recente tramite iCUE. Se il problema non viene risolto, aprire un ticket su support.corsair.com o contattare il team di assistenza clienti per la risoluzione del problema e ulteriore supporto.

<https://help.corsair.com/hc/en-us/requests/new>

5. Che cosa devo fare se la piastra posteriore sembra allentata dopo l'installazione?

È normale che la piastra posteriore sembri allentata quando la installi per la prima volta. Una volta posizionata e fissata la pompa di raffreddamento, questa spingerà la piastra posteriore applicando pressione sul socket tramite il dissipatore.

IMPORTANTE: NON aggiungere, per nessuna ragione, ulteriori guarnizioni e distanziatori alla piastra posteriore per diminuire la pressione nella piastra posteriore. Così facendo, si aumenterà la pressione di montaggio kit di ritenzione e potenzialmente danneggiare il kit di ritenzione, la scheda madre o il socket.

Nota: Casi todos los chasis para PC modernos incluyen un troquelado para la CPU que facilita el acceso a la zona inferior de la placa base. Si su chasis no incluye un troquelado, tendrá que extraer la placa base del chasis antes de la instalación. Los refrigeradores ELITE LCD XT vienen con el soporte de montaje Intel preinstalado en la bomba para una instalación rápida.

ÍNDICE

INTEL (todos los zócalos)

AMD AM5/AM4

AMD sTRX4

INSTALACIÓN



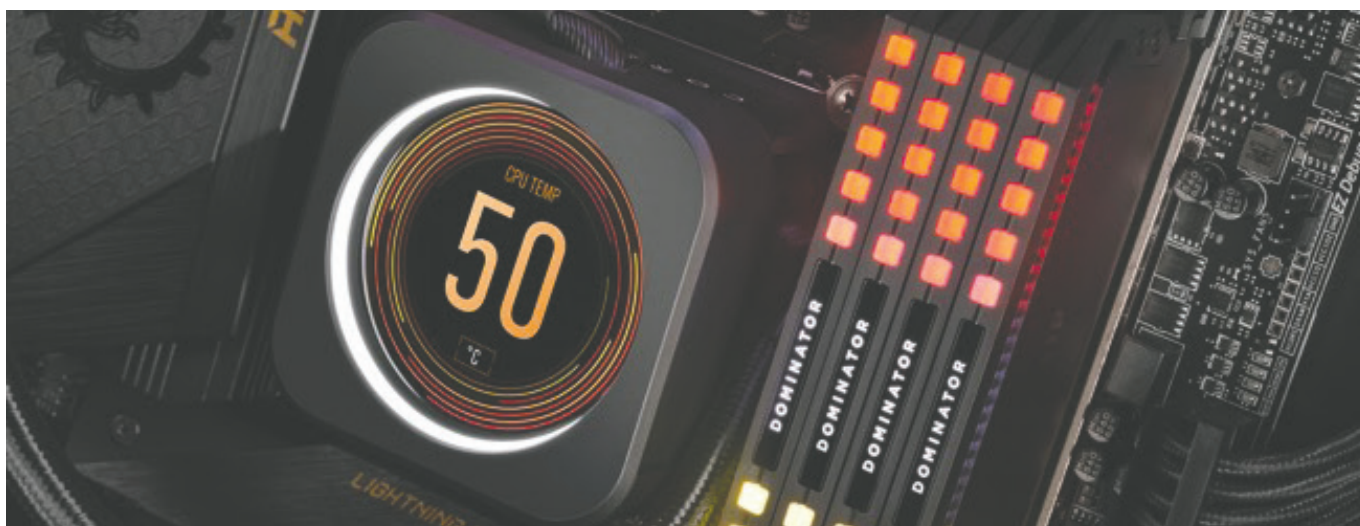





PREGUNTAS FRECUENTES

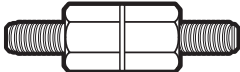
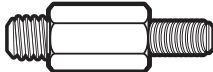

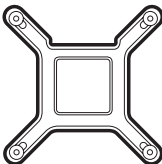
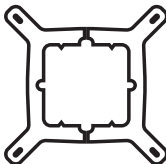
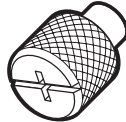
Asegúrese de apagar todo su PC antes de la instalación. El módulo LCD, la bomba y COMMANDER CORE son sensibles a la conexión en caliente y la ESD.

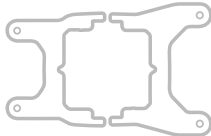
PIEZAS DE MONTAJE INCLUIDAS

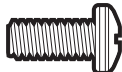
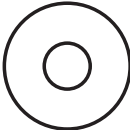
Piezas resaltadas para instalación en Intel solamente

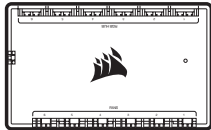
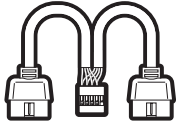
<p>A</p>  <p>x4 SEPARADORES INTEL 1200/1150/1151/1156/1155</p>	<p>B</p>  <p>x4 SEPARADORES INTEL 2011/2011-3/2066</p>	<p>C</p>  <p>x4 SEPARADORES INTEL 1700</p>
<p>D</p>  <p>x1 PLACA DE SOPORTE INTEL</p>	<p>E</p>  <p>x1 SOPORTE DE MONTAJE INTEL (PREINSTALADO)</p>	<p>F</p>  <p>x4 TORNILLOS DE AJUSTE MANUAL</p>
<p>G</p>  <p>x4 SEPARADORES AMD AM5/AM4</p>	<p>H</p>  <p>x1 SOPORTE DE MONTAJE AMD AM5/AM4</p>	<p>I</p>  <p>x1 SOPORTE DE MONTAJE AMD sTR4/sTRX4</p>
<p>J</p>  <p>x4 SEPARADORES AMD sTR4/sTRX4</p>	<p>K</p>  <p>x16 TORNILLOS LARGOS PARA VENTILADOR (H100i) x24 TORNILLOS LARGOS PARA VENTILADOR (H150i/H170i)</p>	<p>L</p>  <p>x8 TORNILLOS PARA RADIADOR (H100i) x12 TORNILLOS PARA RADIADOR (H150i/H170i)</p>
<p>M</p>  <p>x8 ARANDELAS (H100i) x12 ARANDELAS (H150i/H170i)</p>	<p>N</p>  <p>x2 VENTILADORES AF RGB ELITE (H100i) x3 VENTILADORES AF RGB ELITE (H150i/H170i)</p>	<p>O</p>  <p>COMMANDER CORE</p>
<p>P</p>  <p>DIVISOR EN Y USB</p>		

1. INSTALACIÓN DE LA PLACA DE SOPORTE INTEL

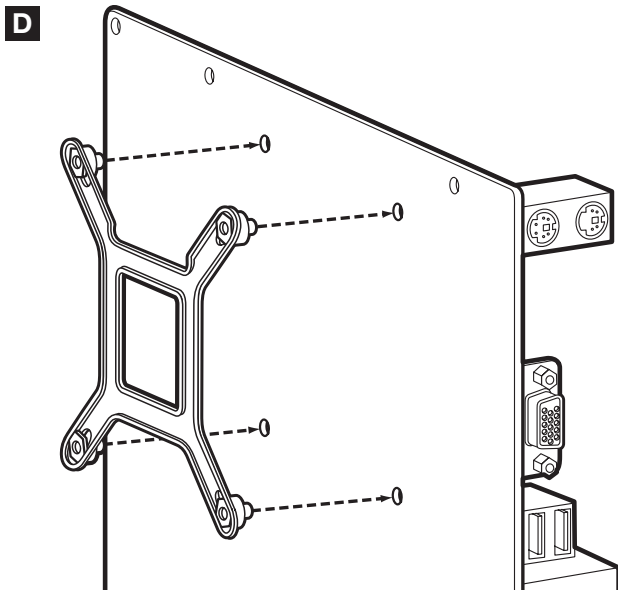

Ajuste la placa de soporte para la toma de corriente necesaria.

Nota: Intel LGA 2011/2011-3/2066 no requieren la instalación de una placa de soporte.

Continúe con el paso 2.

2. INSTALACIÓN DE LOS TORNILLOS DE LOS SEPARADORES INTEL

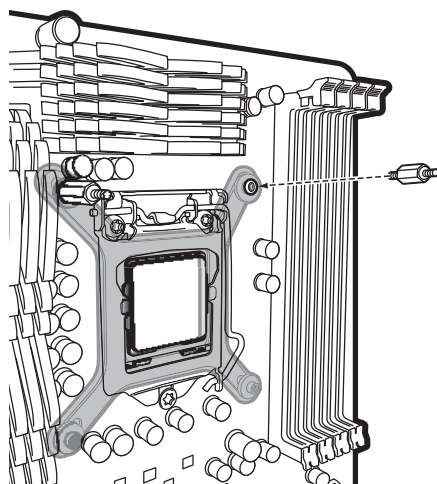

A LGA 1200/1150/
1151/1155/1156

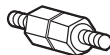

B LGA 2011/
2011-3/2066

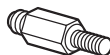

C LGA 1700

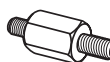

- > Coloque el separador Intel suministrado para su zócalo.
- > Utilice (A) para LGA 1200/115X, (B) para LGA 2011/2011-3/2066 o (C) para LGA 1700.
- > Apriete los cuatro tornillos hasta que estén bien asegurados.

3. INSTALACIÓN DE LOS VENTILADORES Y EL RADIADOR

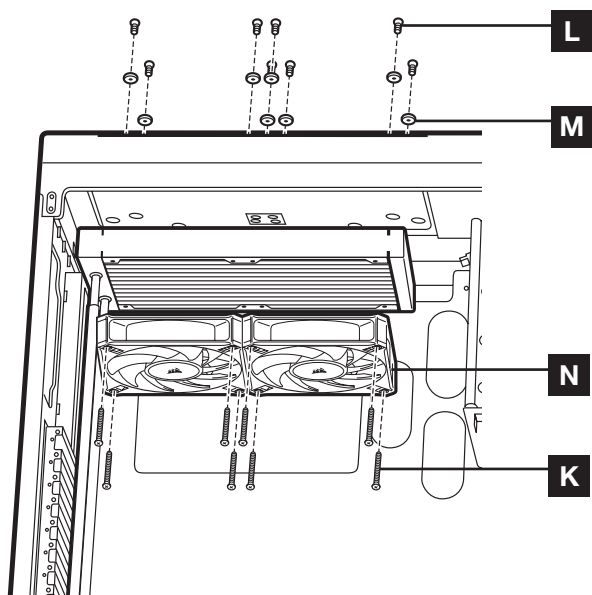

Fije el radiador y los ventiladores tal como se muestra. Para una refrigeración óptima, recomendamos montar los ventiladores como entradas de aire en la carcasa del PC.

4. INSTALACIÓN DE LA UNIDAD DE LA BOMBA

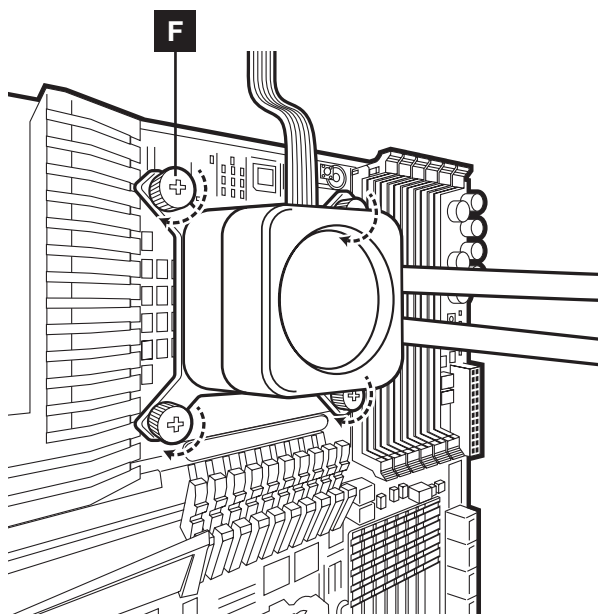







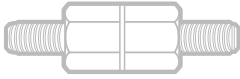

- > Alinee el soporte y la bomba sobre los tornillos de los separadores, tal como se muestra.
- > Coloque los tornillos de ajuste manual (F) en los tornillos de los separadores como se muestra.
- > Apriete los tornillos de ajuste manual hasta que las cuatro esquinas estén bien aseguradas.

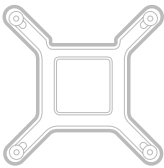
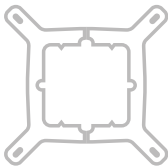
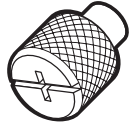
Vaya a la página 10 para continuar con la instalación.

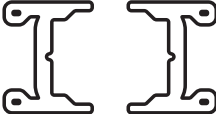
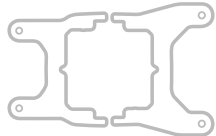
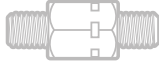
PIEZAS DE MONTAJE INCLUIDAS

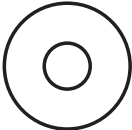
Piezas resaltadas para instalación en AMD AM5/AM4 solamente

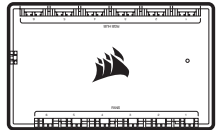
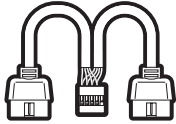
<p>A</p>  <p>x4 SEPARADORES INTEL 1200/1150/1151/1156/1155</p>	<p>B</p>  <p>x4 SEPARADORES INTEL 2011/2011-3/2066</p>	<p>C</p>  <p>x4 SEPARADORES INTEL 1700</p>
<p>D</p>  <p>x1 PLACA DE SOPORTE INTEL</p>	<p>E</p>  <p>x1 SOPORTE DE MONTAJE INTEL (PREINSTALADO)</p>	<p>F</p>  <p>x4 TORNILLOS DE AJUSTE MANUAL</p>
<p>G</p>  <p>x4 SEPARADORES AMD AM5/AM4</p>	<p>H</p>  <p>x1 SOPORTE DE MONTAJE AMD AM5/AM4</p>	<p>I</p>  <p>x1 SOPORTE DE MONTAJE AMD sTR4/sTRX4</p>
<p>J</p>  <p>x4 SEPARADORES AMD sTR4/sTRX4</p>	<p>K</p>  <p>x16 TORNILLOS LARGOS PARA VENTILADOR (H100i) x24 TORNILLOS LARGOS PARA VENTILADOR (H150i/H170i)</p>	<p>L</p>  <p>x8 TORNILLOS PARA RADIADOR (H100i) x12 TORNILLOS PARA RADIADOR (H150i/H170i)</p>
<p>M</p>  <p>x8 ARANDELAS (H100i) x12 ARANDELAS (H150i/H170i)</p>	<p>N</p>  <p>x2 VENTILADORES AF RGB ELITE (H100i) x3 VENTILADORES AF RGB ELITE (H150i/H170i)</p>	<p>O</p>  <p>COMMANDER CORE</p>
<p>P</p>  <p>DIVISOR EN Y USB</p>		

1. INSTALACIÓN DEL SOPORTE DE MONTAJE AMD AM5/AM4



Figura 1



Figura 2

- > Retire el soporte de montaje Intel integrado (figura 1).
- > Instale el soporte AMD AM5/AM4 empujando ambos lados en la ranura de la bomba hasta que quede fijo (figura 2).

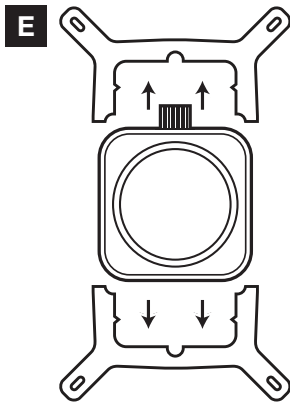
Nota: Es importante que el soporte de retención AMD AM5/AM4 esté uniformemente fijado a todos los lados antes de la instalación.

2. INSTALACIÓN DE LOS VENTILADORES Y EL RADIADOR

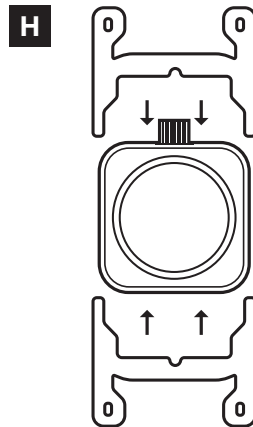
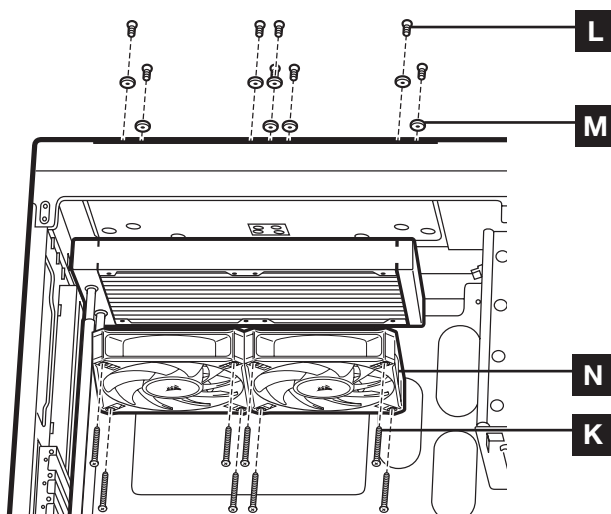

Fije el radiador y los ventiladores tal como se muestra. Para una refrigeración óptima, recomendamos montar los ventiladores como entradas de aire en la carcasa del PC.

3. PREPARE LA PLACA BASE PARA SU INSTALACIÓN

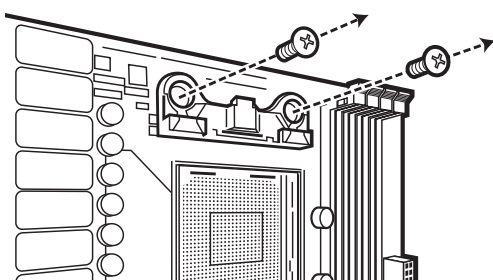

Retire los soportes de montaje AMD AM5/AM4 existentes que se muestran.

4. INSTALACIÓN DE LOS TORNILLOS DE LOS SEPARADORES AMD AM5/AM4

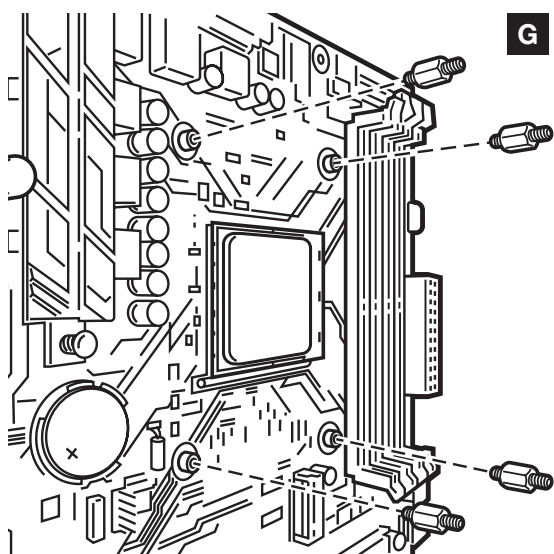

- > Coloque los separadores AMD AM5/AM4 suministrados en el zócalo de la CPU.
- > Apriete los cuatro tornillos hasta que estén bien asegurados.

5. INSTALACIÓN DE LA UNIDAD DE LA BOMBA

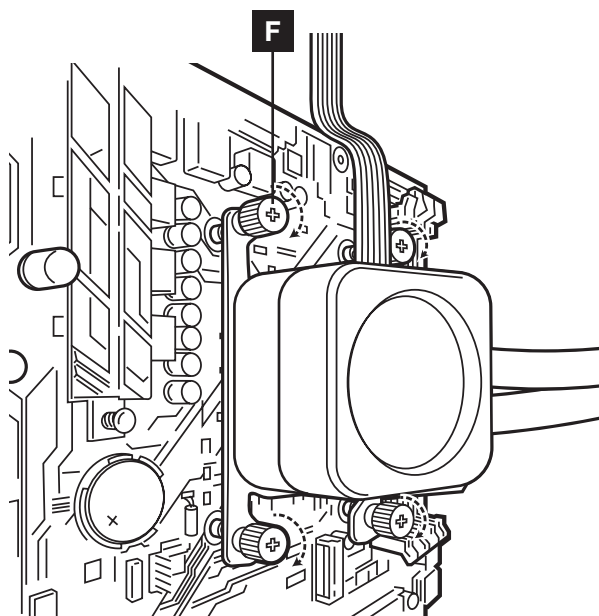







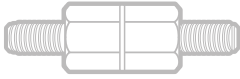

- Alinee el soporte con los separadores AMD AM5/AM4, como se muestra. Apriete los tornillos de ajuste manual (F) por completo.

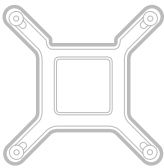
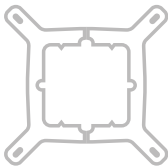
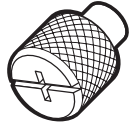
Vaya a la página 10 para continuar con la instalación.

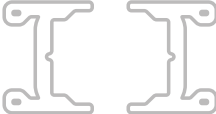
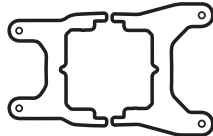
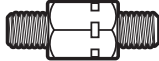
PIEZAS DE MONTAJE INCLUIDAS

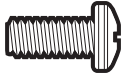
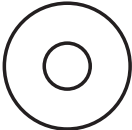
Piezas resaltadas para instalación en AMD sTRX4 solamente

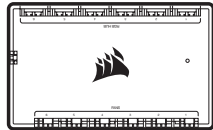
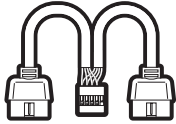
<p>A</p>  <p>x4 SEPARADORES INTEL 1200/1150/1151/1156/1155</p>	<p>B</p>  <p>x4 SEPARADORES INTEL 2011/2011-3/2066</p>	<p>C</p>  <p>x4 SEPARADORES INTEL 1700</p>
<p>D</p>  <p>x1 PLACA DE SOPORTE INTEL</p>	<p>E</p>  <p>x1 SOPORTE DE MONTAJE INTEL (PREINSTALADO)</p>	<p>F</p>  <p>x4 TORNILLOS DE AJUSTE MANUAL</p>
<p>G</p>  <p>x4 SEPARADORES AMD AM5/AM4</p>	<p>H</p>  <p>x1 SOPORTE DE MONTAJE AMD AM5/AM4</p>	<p>I</p>  <p>x1 SOPORTE DE MONTAJE AMD sTR4/sTRX4</p>
<p>J</p>  <p>x4 SEPARADORES AMD sTR4/sTRX4</p>	<p>K</p>  <p>x16 TORNILLOS LARGOS PARA VENTILADOR (H100i) x24 TORNILLOS LARGOS PARA VENTILADOR (H150i/H170i)</p>	<p>L</p>  <p>x8 TORNILLOS PARA RADIADOR (H100i) x12 TORNILLOS PARA RADIADOR (H150i/H170i)</p>
<p>M</p>  <p>x8 ARANDELAS (H100i) x12 ARANDELAS (H150i/H170i)</p>	<p>N</p>  <p>x2 VENTILADORES AF RGB ELITE (H100i) x3 VENTILADORES AF RGB ELITE (H150i/H170i)</p>	<p>O</p>  <p>COMMANDER CORE</p>
<p>P</p>  <p>DIVISOR EN Y USB</p>		

1. INSTALACIÓN DEL SOPORTE DE MONTAJE AMD sTRX4

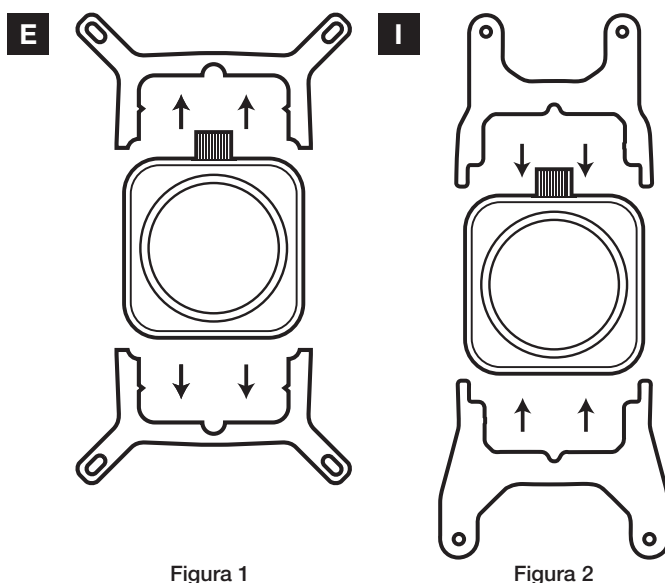

- > Retire el soporte de montaje Intel integrado (figura 1).
- > Instale el soporte AMD sTRX4 empujando ambos lados en la ranura de la bomba hasta que quede fijo (figura 2).

Nota: Es importante que el soporte de retención AMD sTRX4 esté uniformemente fijado a todos los lados antes de la instalación.

2. INSTALACIÓN DE LOS TORNILLOS DE LOS SEPARADORES AMD sTRX4

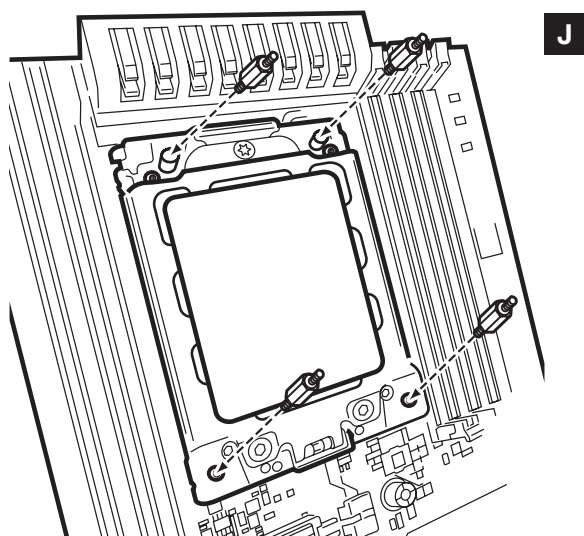

- > Coloque los separadores AMD sTRX4 suministrados en el zócalo de la CPU.
- > Apriete los cuatro tornillos hasta que estén bien asegurados.

3. INSTALACIÓN DE LOS VENTILADORES Y EL RADIADOR

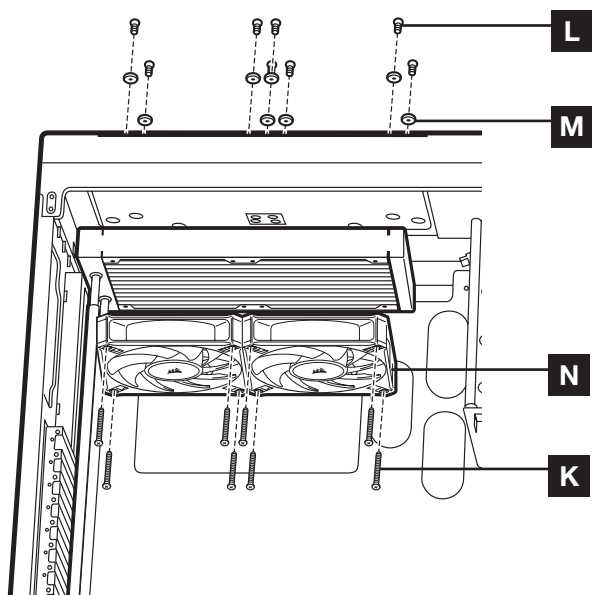

Fije el radiador y los ventiladores tal como se muestra. Para una refrigeración óptima, recomendamos montar los ventiladores como entradas de aire en la carcasa del PC.

4. INSTALACIÓN DE LA UNIDAD DE LA BOMBA

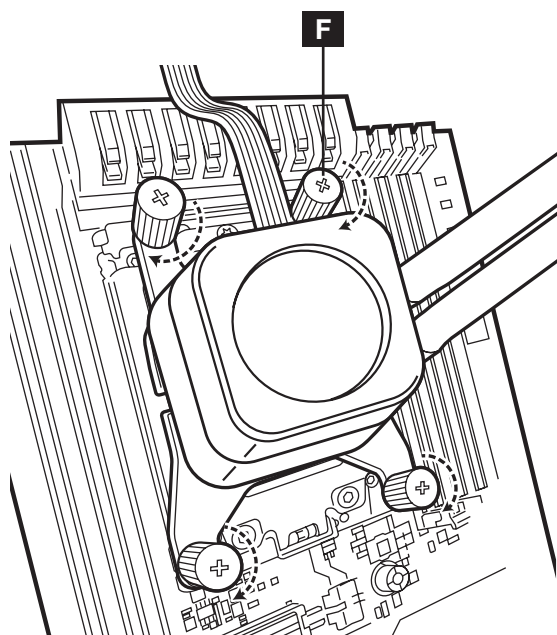

- > Alinee el soporte y la bomba sobre los tornillos de los separadores, tal como se muestra.
- > Coloque los tornillos de ajuste manual (F) en los tornillos de los separadores como se muestra.
- > Apriete los tornillos de ajuste manual hasta que las cuatro esquinas estén bien aseguradas.

Vaya a la página 10 para continuar con la instalación.

CONECTE LOS VENTILADORES Y LA BOMBA AL COMMANDER CORE

- > Conecte el cable de 24 patillas de la bomba a COMMANDER CORE (figura 1).
- > Conecte el cable tach de la bomba al cabezal CPU_FAN de la placa base (figura 2).
- > Conecte cada ventilador al COMMANDER CORE (figura 3).
- > Conecte cada LED RGB de ventilador al COMMANDER CORE (figura 3).



Figura 1

Figura 2

Figura 3

CONECTE COMMANDER CORE Y EL MÓDULO ELITE LCD XT AL CABEZAL USB 2.0 Y A LA ALIMENTACIÓN

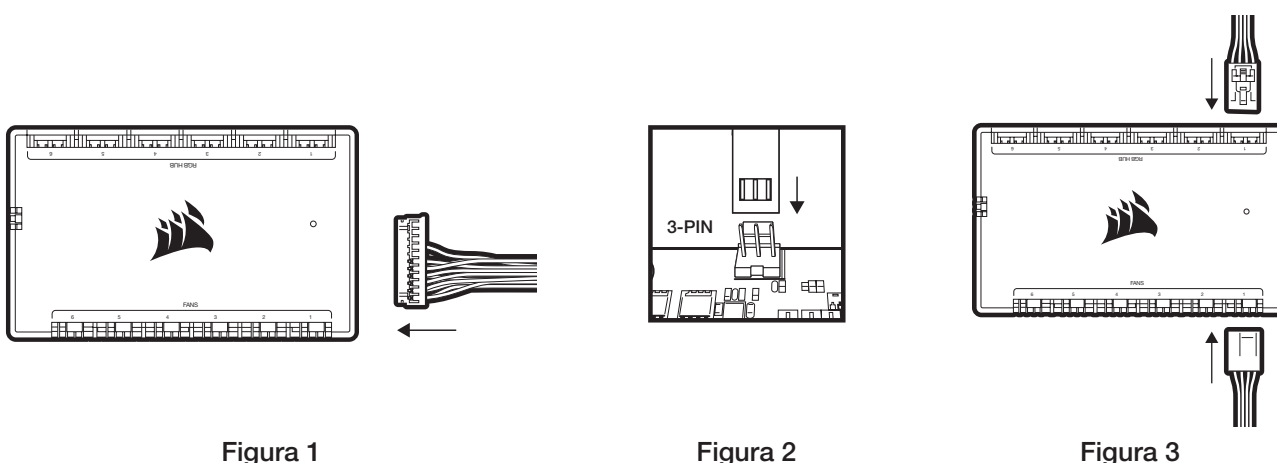
- > Utilizando el cable USB-C incluido, conecte el COMMANDER CORE a un cabezal USB 2.0 de la placa base.
- > Conecte el cable de alimentación de la bomba a una toma de alimentación SATA disponible en la fuente de alimentación.
- > Utilice el divisor USB en Y incluido para reducir los puertos USB necesarios de 2 a 1.

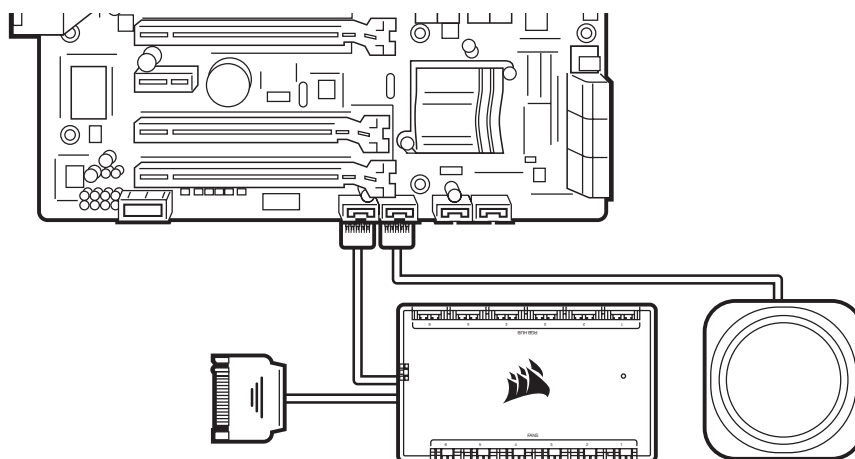

PREGUNTAS FRECUENTES

1. ¿Cómo puedo saber el sentido en que circula el aire del ventilador?

En el lateral del ventilador, hay una flecha que indica el sentido del flujo de aire.

2. ¿Puedo reutilizar la pasta térmica aplicada de fábrica en el refrigerador para volver a instalarlo?

Para volver a instalar el refrigerador, es preciso limpiar a fondo la pasta térmica aplicada de fábrica y aplicar una capa de pasta térmica nueva XTM70 (de venta por separado).

3. ¿En qué orientación debo instalar mi radiador?

La mejor forma de instalar un radiador es con los tubos en la parte inferior del chasis, aunque se puede instalar con los tubos en cualquier posición, incluso un radiador invertido, siempre que el punto más elevado del radiador esté visiblemente más elevado que la bomba de la CPU.

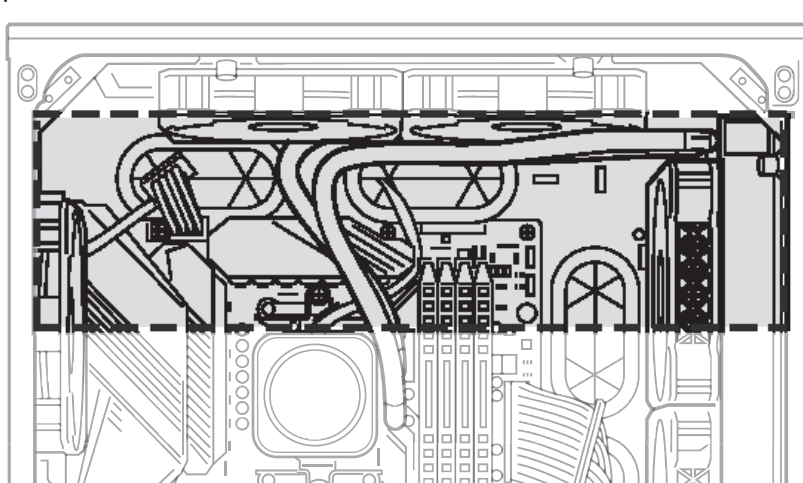

4. El refrigerador y los ventiladores parpadean en rojo y no funcionan. ¿Qué debo hacer?

Revise todas las conexiones desde el refrigerador y los ventiladores hasta el COMMANDER CORE. Asegúrese de que COMMANDER CORE y el módulo LCD estén actualizados con el firmware más reciente a través de iCUE. Si con eso no se solucionan los problemas, abra un ticket en support.corsair.com o póngase en contacto con el equipo de atención al cliente para que le ayuden y le ofrezcan otras soluciones.

<https://help.corsair.com/hc/en-us/requests/new>

5. ¿Qué debo hacer si la placa de soporte del refrigerador parece suelta después de la instalación?

Es común que la placa de soporte del refrigerador parezca suelta después de instalarla en la placa base por primera vez. Una vez que haya alojado y fijado la bomba del refrigerador, esta tirará de la placa de soporte a la placa base y aplicará presión sobre el zócalo mediante el refrigerador.

IMPORTANTE: NO añada, bajo ninguna circunstancia, arandelas o espaciadores adicionales a la placa de soporte para disminuir la holgura de la placa de soporte. Si lo hace, aumentará la presión de montaje del kit de retención y es posible que dañe el kit, la placa base o el zócalo.

Nota: A maior parte das torres de PC mais recentes inclui um recorte de CPU para permitir o acesso ao fundo da placa principal. Se a sua torre não incluir um recorte, terá de remover a sua placa principal da torre antes da instalação. Os refrigeradores ELITE LCD XT vêm com o suporte de montagem Intel pré-instalado na bomba para uma rápida instalação.

ÍNDICE

INTEL (Todas as tomadas)

AMD AM5/AM4

AMD sTRX4

INSTALAÇÃO









PERGUNTAS FREQUENTES

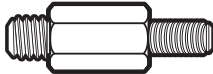

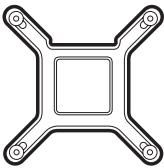
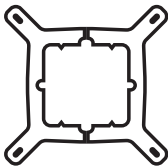
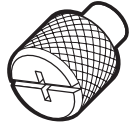
Certifique-se de que desliga todo o PC antes da instalação. O módulo de LCD, a bomba e o COMMANDER CORE são sensíveis às instalações instantâneas (hot-plugging) e à descarga eletrostática.

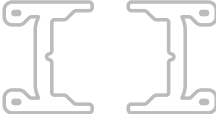
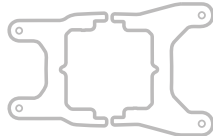
HARDWARE INCLUÍDO

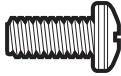
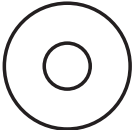
As peças realçadas são apenas para a instalação Intel

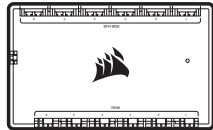
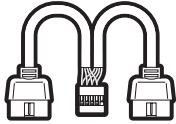
<p>A</p>  <p>x4 ESPAÇADORES INTEL 1200/1150/1151/1156/1155</p>	<p>B</p>  <p>x4 ESPAÇADORES INTEL 2011/2011-3/2066</p>	<p>C</p>  <p>x4 ESPAÇADORES INTEL 1700</p>
<p>D</p>  <p>x1 PLACA TRASEIRA INTEL</p>	<p>E</p>  <p>x1 SUPORTE DE MONTAGEM INTEL (PRÉ-INSTALADO)</p>	<p>F</p>  <p>x4 PARAFUSOS DE POLEGAR</p>
<p>G</p>  <p>x4 ESPAÇADORES AMD AM5/AM4</p>	<p>H</p>  <p>x1 SUPORTE DE MONTAGEM AMD AM5/AM4</p>	<p>I</p>  <p>x1 SUPORTE DE MONTAGEM AMD sTR4/sTRX4</p>
<p>J</p>  <p>x4 ESPAÇADORES AMD sTR4/sTRX4</p>	<p>K</p>  <p>x16 PARAFUSOS DE VENTONHA LONGOS (H100i) x24 PARAFUSOS DE VENTONHA LONGOS (H150i/ H170i)</p>	<p>L</p>  <p>x8 PARAFUSOS DO RADIADOR (H100i) x12 PARAFUSOS DO RADIADOR (H150i/H170i)</p>
<p>M</p>  <p>x8 ANILHAS (H100i) x12 ANILHAS (H150i/H170i)</p>	<p>N</p>  <p>x2 VENTONHAS AF RGB ELITE (H100i) x3 VENTONHAS AF RGB ELITE (H150i/H170i)</p>	<p>O</p>  <p>COMMANDER CORE</p>
<p>P</p>  <p>DIVISOR USB EM Y</p>		

1. INSTALAR A PLACA TRASEIRA INTEL

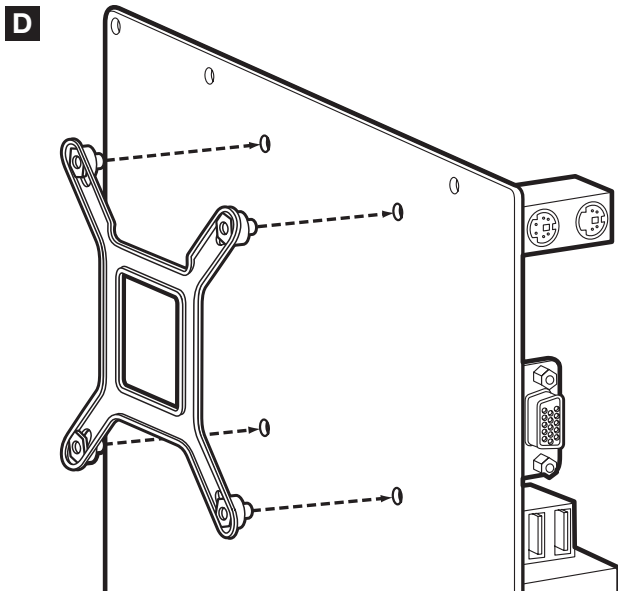

Ajuste a placa traseira para a tomada necessária.

Nota: Para Intel LGA 2011/2011-3/2066, não é necessária a instalação da placa traseira.

Prossiga para o passo 2.

2. INSTALAR OS PARAFUSOS DOS ESPAÇADORES INTEL

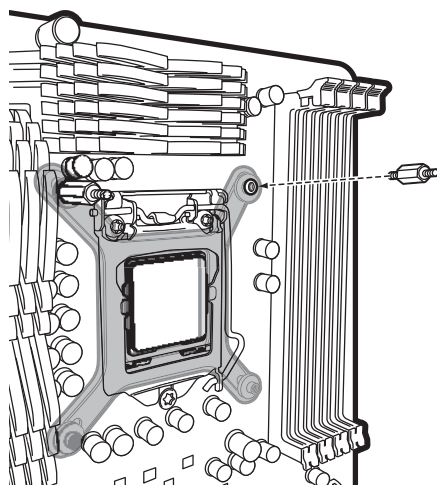

A LGA 1200/1150/
1151/1155/1156

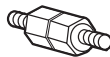

B LGA 2011/
2011-3/2066

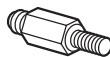

C LGA 1700

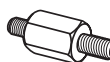

- > Coloque o espaçador Intel fornecido para a tomada.
- > Utilize (A) para LGA 1200/115X, (B) para LGA 2011/2011-3/2066 ou (C) para LGA 1700.
- > Aperte os quatro parafusos até que fiquem bem fixos.

3. INSTALAR AS VENTOINHAS E O RADIADOR

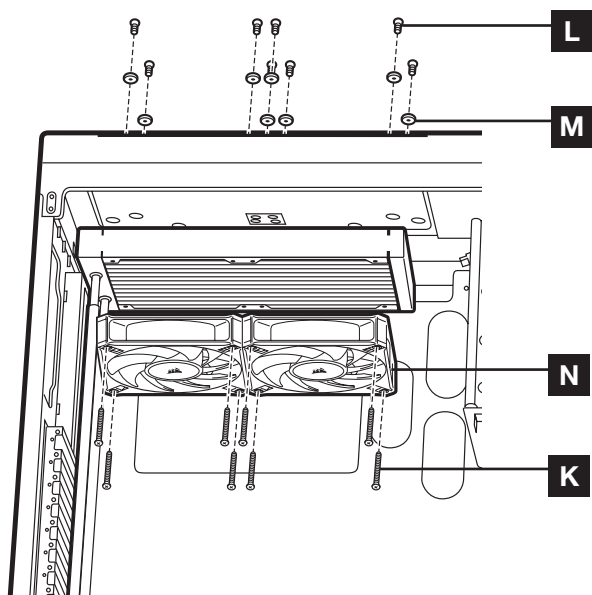

Coloque o radiador e as ventoinhas como apresentado. Para obter o melhor desempenho de arrefecimento, recomendamos a montagem das ventoinhas como uma entrada de ar para a torre de PC.

4. INSTALAR A UNIDADE DA BOMBA

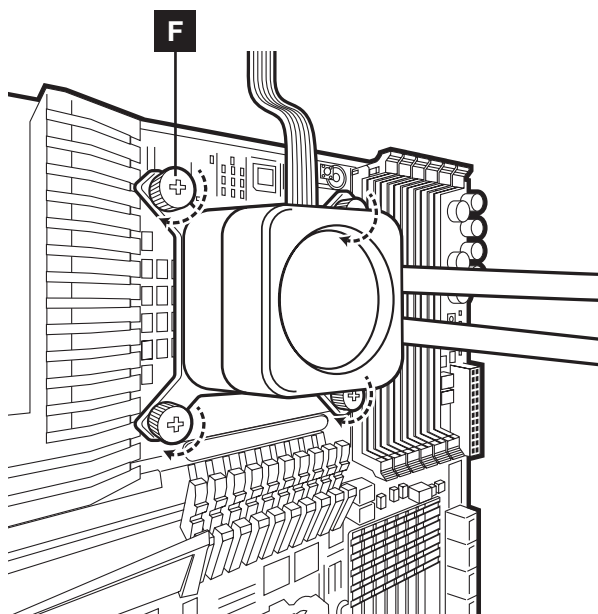







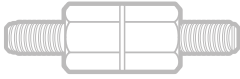

- > Alinhe o suporte e a bomba sobre os parafusos dos espaçadores, como apresentado.
- > Coloque os parafusos de polegar (F) nos parafusos dos espaçadores, como apresentado.
- > Aperte os parafusos de polegar até que os quatro cantos estejam bem fixos.

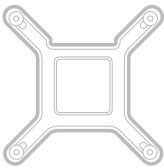
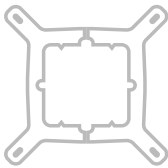
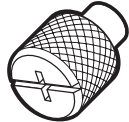
Continue para a página 10 para prosseguir com a instalação.

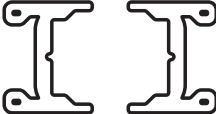
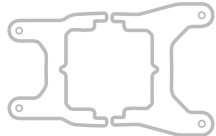
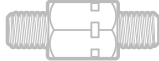
HARDWARE INCLUÍDO

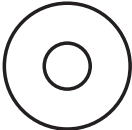
As peças realçadas são apenas para a instalação AMD AM5/AM4

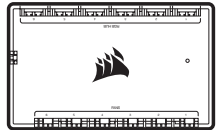
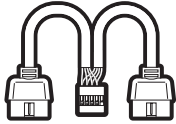
<p>A</p>  <p>x4 ESPAÇADORES INTEL 1200/1150/1151/1156/1155</p>	<p>B</p>  <p>x4 ESPAÇADORES INTEL 2011/2011-3/2066</p>	<p>C</p>  <p>x4 ESPAÇADORES INTEL 1700</p>
<p>D</p>  <p>x1 PLACA TRASEIRA INTEL</p>	<p>E</p>  <p>x1 SUPORTE DE MONTAGEM INTEL (PRÉ-INSTALADO)</p>	<p>F</p>  <p>x4 PARAFUSOS DE POLEGAR</p>
<p>G</p>  <p>x4 ESPAÇADORES AMD AM5/AM4</p>	<p>H</p>  <p>x1 SUPORTE DE MONTAGEM AMD AM5/AM4</p>	<p>I</p>  <p>x1 SUPORTE DE MONTAGEM AMD sTR4/sTRX4</p>
<p>J</p>  <p>x4 ESPAÇADORES AMD sTR4/sTRX4</p>	<p>K</p>  <p>x16 PARAFUSOS DE VENTOINHA LONGOS (H100i) x24 PARAFUSOS DE VENTOINHA LONGOS (H150i/ H170i)</p>	<p>L</p>  <p>x8 PARAFUSOS DO RADIADOR (H100i) x12 PARAFUSOS DO RADIADOR (H150i/H170i)</p>
<p>M</p>  <p>x8 ANILHAS (H100i) x12 ANILHAS (H150i/H170i)</p>	<p>N</p>  <p>x2 VENTOINHAS AF RGB ELITE (H100i) x3 VENTOINHAS AF RGB ELITE (H150i/H170i)</p>	<p>O</p>  <p>COMMANDER CORE</p>
<p>P</p>  <p>DIVISOR USB EM Y</p>		

1. INSTALAR O SUPORTE DE MONTAGEM AMD AM5/AM4



Figura 1



Figura 2

- > Retire o suporte de montagem Intel integrado (Figura 1).
- > Instale o suporte AMD AM5/AM4 pressionando ambos os lados para dentro da ranhura da bomba até fixar (Figura 2).

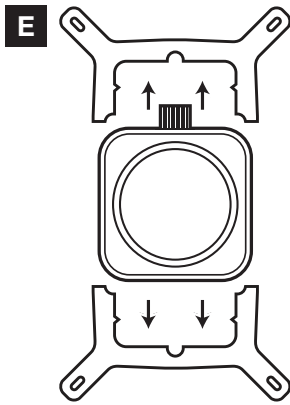
Nota: É importante que o suporte de retenção AMD AM5/AM4 fique bem fixo a todos os lados antes da instalação.

2. INSTALAR AS VENTOINHAS E O RADIADOR

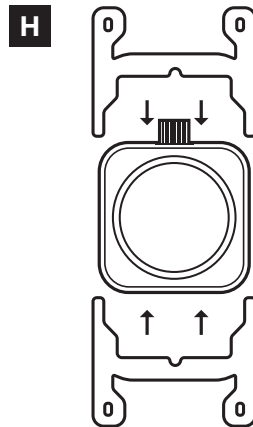
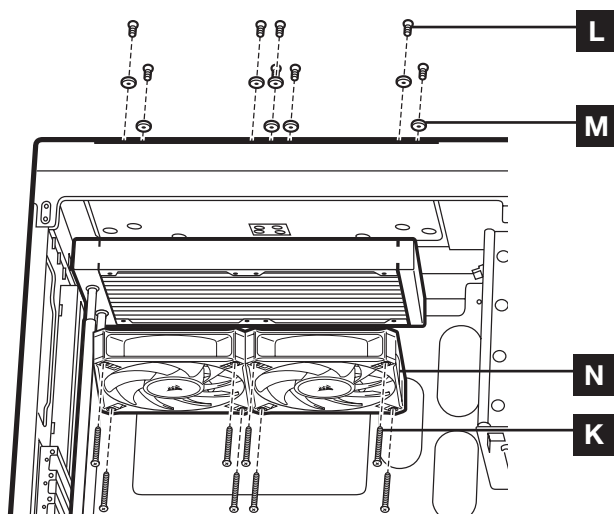

Coloque o radiador e as ventoinhas como apresentado. Para obter o melhor desempenho de arrefecimento, recomendamos a montagem das ventoinhas como uma entrada de ar para a torre de PC.

3. PREPARAR A PLACA PRINCIPAL PARA A INSTALAÇÃO

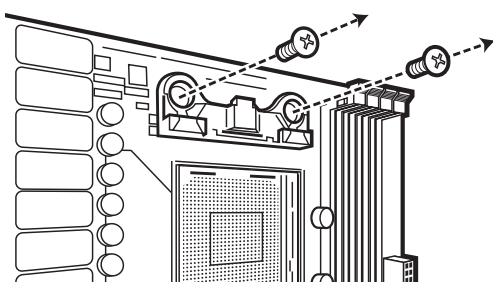

Retire os suportes de montagem AMD AM5/AM4 existentes apresentados.

4. INSTALAR OS PARAFUSOS DOS ESPAÇADORES AMD AM5/AM4

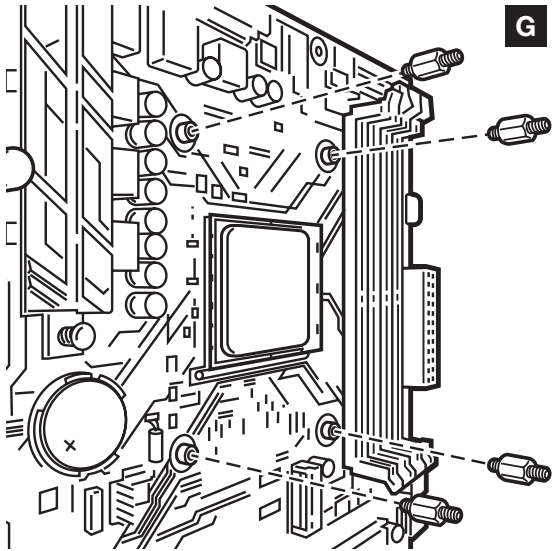

- > Coloque os espaçadores AMD AM5/AM4 fornecidos na tomada do processador.
- > Aperte os quatro parafusos até que fiquem bem fixos.

5. INSTALAR A UNIDADE DA BOMBA

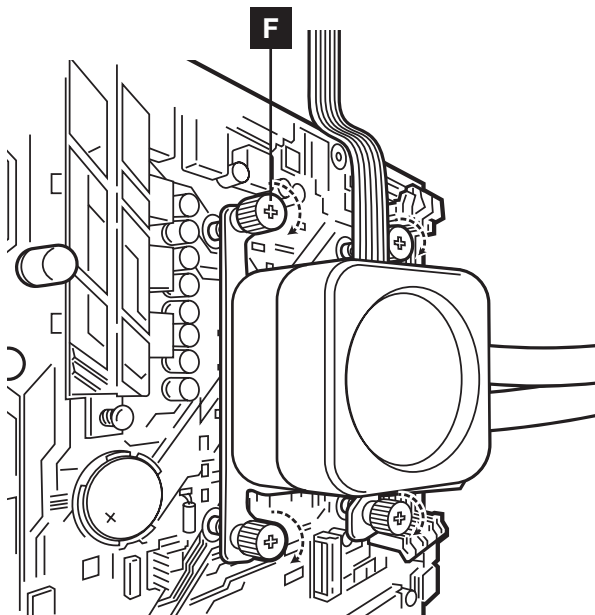







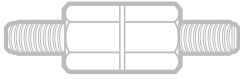

Alinhe o suporte com os espaçadores AMD AM5/AM4, como apresentado. Aperte os parafusos de polegar (F) até que estejam fixos.

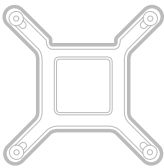
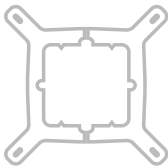
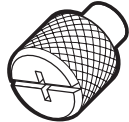
Continue para a página 10 para prosseguir com a instalação.

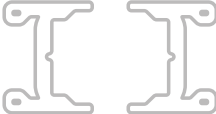
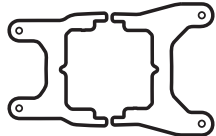
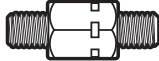
HARDWARE INCLUÍDO

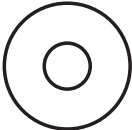
As peças realçadas são apenas para a instalação AMD sTRX4

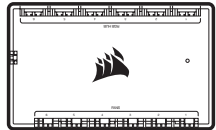
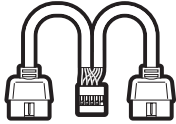
<p>A</p>  <p>x4 ESPAÇADORES INTEL 1200/1150/1151/1156/1155</p>	<p>B</p>  <p>x4 ESPAÇADORES INTEL 2011/2011-3/2066</p>	<p>C</p>  <p>x4 ESPAÇADORES INTEL 1700</p>
<p>D</p>  <p>x1 PLACA TRASEIRA INTEL</p>	<p>E</p>  <p>x1 SUPORTE DE MONTAGEM INTEL (PRÉ-INSTALADO)</p>	<p>F</p>  <p>x4 PARAFUSOS DE POLEGAR</p>
<p>G</p>  <p>x4 ESPAÇADORES AMD AM5/AM4</p>	<p>H</p>  <p>x1 SUPORTE DE MONTAGEM AMD AM5/AM4</p>	<p>I</p>  <p>x1 SUPORTE DE MONTAGEM AMD sTR4/sTRX4</p>
<p>J</p>  <p>x4 ESPAÇADORES AMD sTR4/sTRX4</p>	<p>K</p>  <p>x16 PARAFUSOS DE VENTONHA LONGOS (H100i) x24 PARAFUSOS DE VENTONHA LONGOS (H150i/ H170i)</p>	<p>L</p>  <p>x8 PARAFUSOS DO RADIADOR (H100i) x12 PARAFUSOS DO RADIADOR (H150i/H170i)</p>
<p>M</p>  <p>x8 ANILHAS (H100i) x12 ANILHAS (H150i/H170i)</p>	<p>N</p>  <p>x2 VENTONHAS AF RGB ELITE (H100i) x3 VENTONHAS AF RGB ELITE (H150i/H170i)</p>	<p>O</p>  <p>COMMANDER CORE</p>
<p>P</p>  <p>DIVISOR USB EM Y</p>		

1. INSTALAR O SUPORTE DE MONTAGEM AMD sTRX4

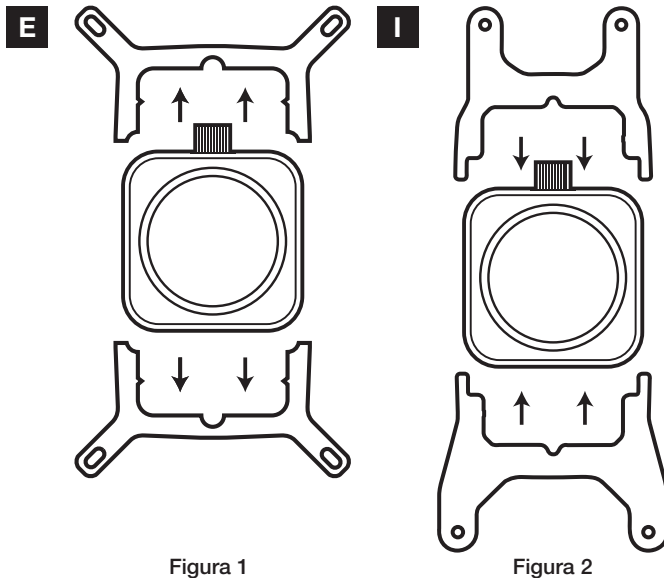

- > Retire o suporte de montagem Intel integrado (Figura 1).
- > Instale o suporte AMD sTRX4 pressionando ambos os lados para dentro da ranhura da bomba até fixar (Figura 2).

Nota: É importante que o suporte de retenção AMD sTRX4 fique bem fixo a todos os lados antes da instalação.

2. INSTALAR OS PARAFUSOS DOS ESPAÇADORES AMD sTRX4

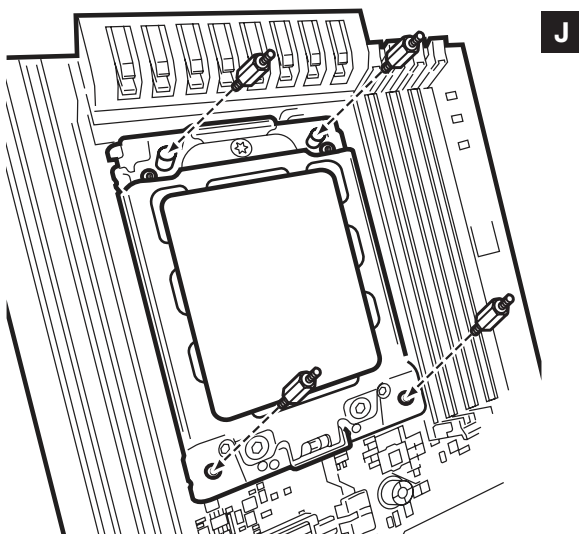

- > Coloque os espaçadores AMD sTRX4 fornecidos na tomada do processador.
- > Aperte os quatro parafusos até que fiquem bem fixos.

3. INSTALAR AS VENTOINHAS E O RADIADOR

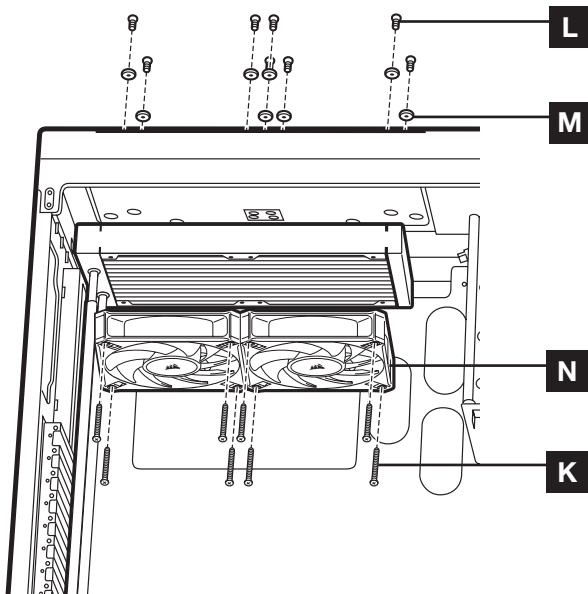

Coloque o radiador e as ventoinhas como apresentado. Para obter o melhor desempenho de arrefecimento, recomendamos a montagem das ventoinhas como uma entrada de ar para a torre de PC.

4. INSTALAR A UNIDADE DA BOMBA

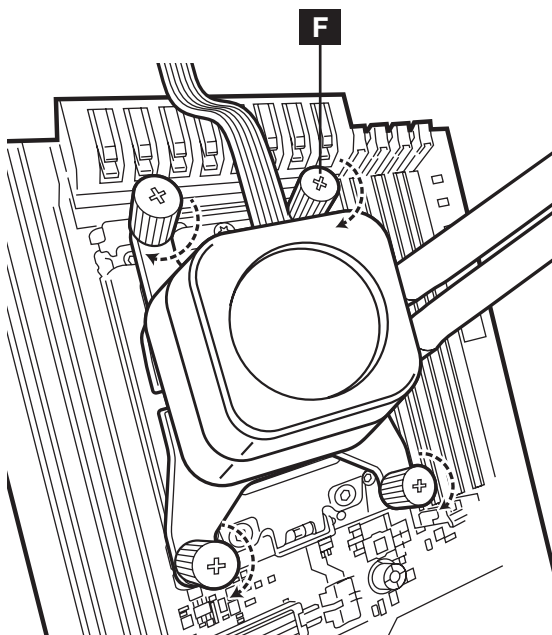

- > Alinhe o suporte e a bomba sobre os parafusos dos espaçadores, como apresentado.
- > Coloque os parafusos de polegar (F) nos parafusos dos espaçadores, como apresentado.
- > Aperte os parafusos de polegar até que os quatro cantos estejam bem fixos.

Continue para a página 10 para prosseguir com a instalação.

LIGAR AS VENTOINHAS E A BOMBA AO COMMANDER CORE

- > Ligue o cabo de 24 pinos da bomba ao COMMANDER CORE (Figura 1).
- > Ligue o cabo do tacómetro da bomba ao coletor da ventoinha do processador da placa principal (Figura 2).
- > Ligue cada ventoinha ao COMMANDER CORE (Figura 3).
- > Ligue cada cabo RGB da ventoinha ao COMMANDER CORE (Figura 3).



Figura 1



Figura 2

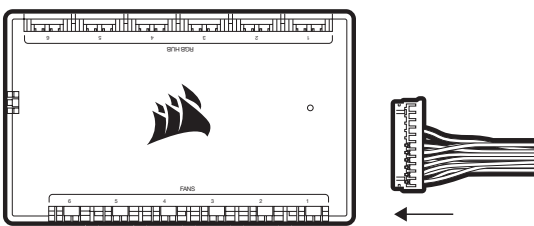

Figura 3

LIGAR O COMMANDER CORE E O MÓDULO ELITE LCD XT AO COLETOR USB 2.0 E À ALIMENTAÇÃO

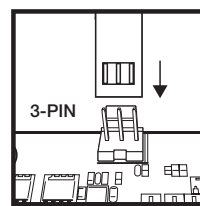
- > Com o cabo USB existente, ligue o COMMANDER CORE a um coletor USB 2.0 da placa principal.
- > Ligue o cabo de alimentação da bomba a uma ficha de alimentação SATA disponível na sua fonte de alimentação.
- > Utilize o divisor USB em Y incluído para reduzir as portas USB necessárias de 2 para 1.

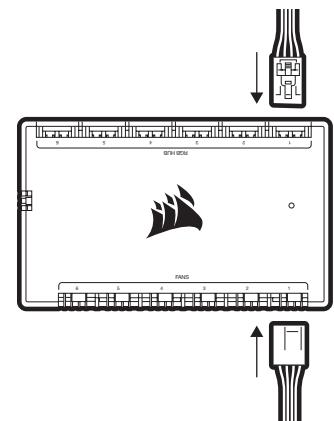
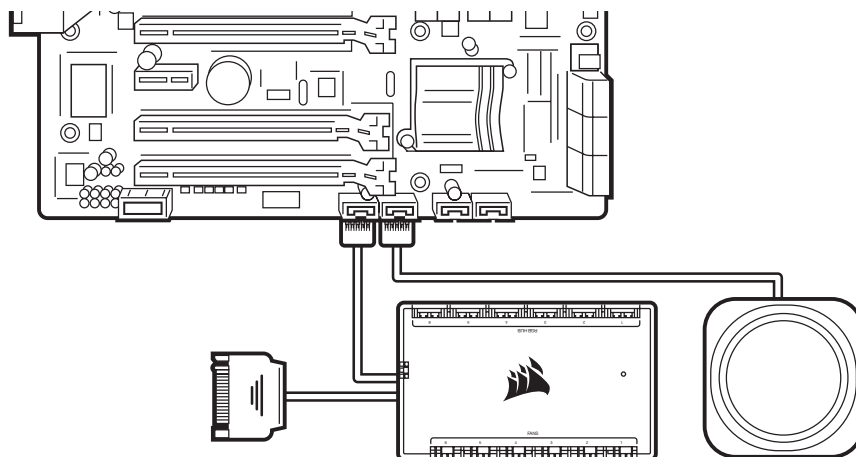

PERGUNTAS FREQUENTES

1. Como sei a direção do fluxo de ar da ventoinha?

Uma seta situada na lateral da ventoinha indica a direção do fluxo de ar.

2. Posso reutilizar a pasta térmica pré-aplicada no refrigerador para a reinstalação?

Para instalar novamente o refrigerador, terá de remover a pasta térmica pré-aplicada e voltar a aplicar a pasta térmica XTM70 (vendida separadamente).

3. Com que orientação devo instalar o radiador?

A melhor forma de instalar um radiador é com os tubos na parte inferior da torre, apesar de o poder instalar com os tubos em qualquer posição, incluindo numa posição de inversão do radiador, desde que o ponto mais alto do radiador fique visivelmente superior à bomba do processador.

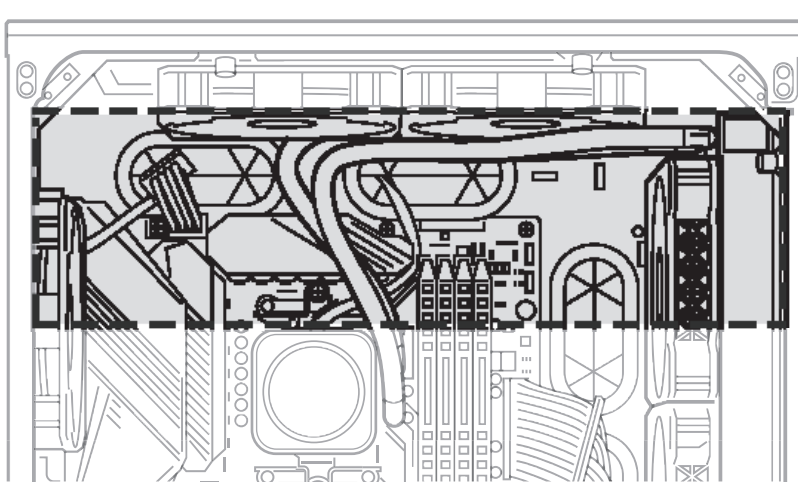

4. O meu refrigerador e as ventoinhas estão a piscar a vermelho ou não funcionam. O que devo fazer?

Verifique todas as ligações do refrigerador e das ventoinhas para o COMMANDER CORE. Certifique-se de que o COMMANDER CORE e o módulo de LCD estão atualizados com o firmware mais recente via iCUE. Se isto não resolver os seus problemas, abra um ticket em support.corsair.com ou contacte a nossa equipa de apoio ao cliente para obter assistência e informações sobre a resolução de problemas.

<https://help.corsair.com/hc/en-us/requests/new>

5. O que devo fazer se a placa traseira do refrigerador parecer estar solta após a instalação?

É frequente que a placa traseira do refrigerador pareça estar solta depois de a instalar na placa principal pela primeira vez. Depois de ter assentado e apertado a bomba do refrigerador, isso puxa a placa traseira para a placa principal e aplica pressão na tomada através do refrigerador.

IMPORTANTE: NÃO deve, em nenhuma circunstância, adicionar anilhas e espaçadores adicionais à placa traseira para reduzir a respetiva folga. Se o fizer, aumenta a pressão de fixação no kit de retenção e pode danificar o kit de retenção, a placa principal ou a tomada.

Uwaga: Nowsze obudowy komputerowe mają zwykle wycięcie na procesor, które umożliwia dostęp do spodu płyty głównej. Jeśli w obudowie nie ma wycięcia, przed instalacją należy wyjąć płytę główną z obudowy. Układy chłodzące ELITE LCD XT mają zamontowany fabrycznie na pompce uchwyt mocujący Intel, który umożliwia szybką instalację.

SPIS TREŚCI

INTEL (wszystkie gniazda)

AMD AM5/AM4

AMD sTRX4

MONTAŻ



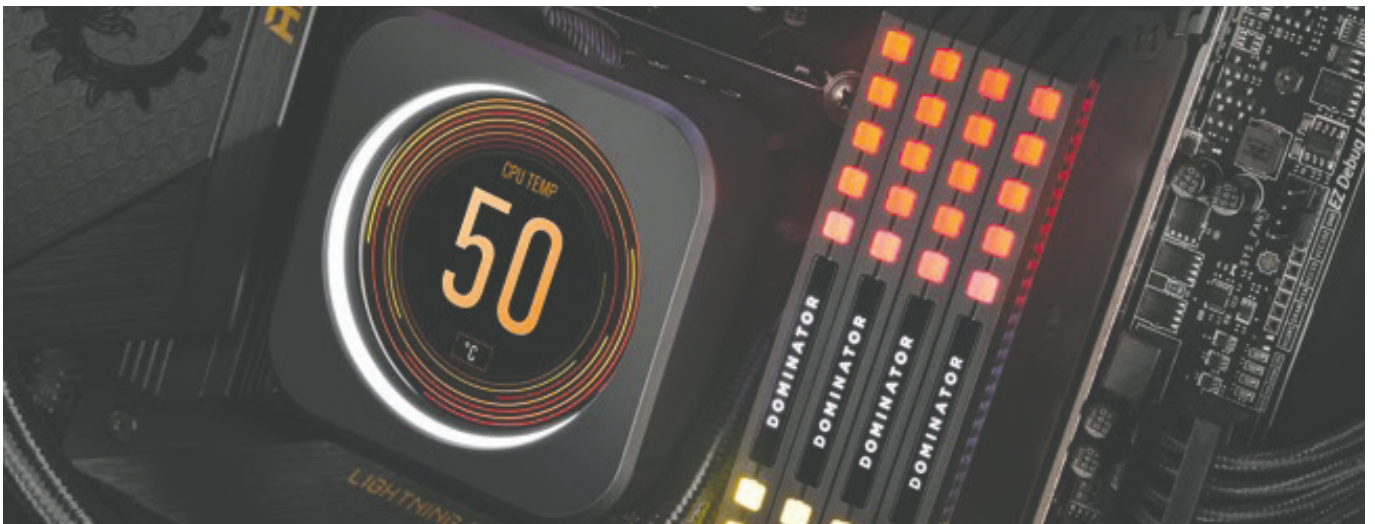





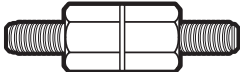
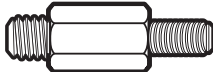

CZĘSTO ZADAWANE PYTANIA

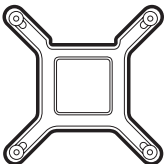
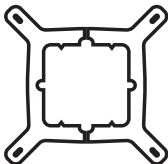
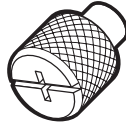

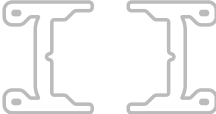
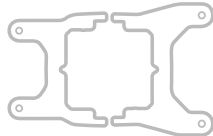
Przed instalacją całkowicie odłącz komputer od zasilania. Moduł LCD, pompka i COMMANDER CORE są bardzo wrażliwe na podłączenie przy włączonym zasilaniu i wyladowania elektrostatyczne.

WYPOSAŻENIE

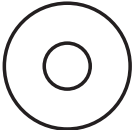
Wyróżnione części dotyczą tylko instalacji produktów Intel

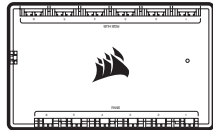
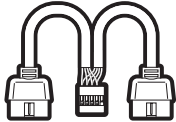
<p>A</p>  <p>x4 ŚRUBY DYSTANSOWE INTEL 1200/1150/1151/1156/1155</p>	<p>B</p>  <p>x4 ŚRUBY DYSTANSOWE INTEL 2011/2011-3/2066</p>	<p>C</p>  <p>x4 ŚRUBY DYSTANSOWE INTEL 1700</p>
<p>D</p>  <p>x1 PODSTAWKA MONTAŻOWA INTEL</p>	<p>E</p>  <p>x1 UCHWYT MOCUJĄCY INTEL (ZAMONTOWANY FABRYCZNIE)</p>	<p>F</p>  <p>x4 ŚRUBY RADEŁKOWANE</p>
<p>G</p>  <p>x4 ŚRUBY DYSTANSOWE AMD AM5/AM4</p>	<p>H</p>  <p>x1 UCHWYT MOCUJĄCY AMD AM5/AM4</p>	<p>I</p>  <p>x1 UCHWYT MOCUJĄCY AMD sTR4/STRX4</p>
<p>J</p>  <p>x4 ŚRUBY DYSTANSOWE AMD sTR4/STRX4</p>	<p>K</p>  <p>x16 DŁUGICH ŚRUB DO WENTYLATORÓW (H100i) x24 DŁUGIE ŚRUBY DO WENTYLATORÓW (H150i/ H170i)</p>	<p>L</p>  <p>x8 ŚRUB DO RADIATORA (H100i) x12 ŚRUB DO RADIATORA (H150i/H170i)</p>
<p>M</p>  <p>x8 PODKŁADEK (H100i) x12 PODKŁADEK (H150i/H170i)</p>	<p>N</p>  <p>x2 WENTYLATORY AF RGB ELITE (H100i) x3 WENTYLATORY AF RGB ELITE (H150i/H170i)</p>	<p>O</p>  <p>COMMANDER CORE</p>
<p>P</p>  <p>ROZDZIELACZ USB</p>		

1. MONTOWANIE PODSTAWKI MONTAŻOWEJ INTEL

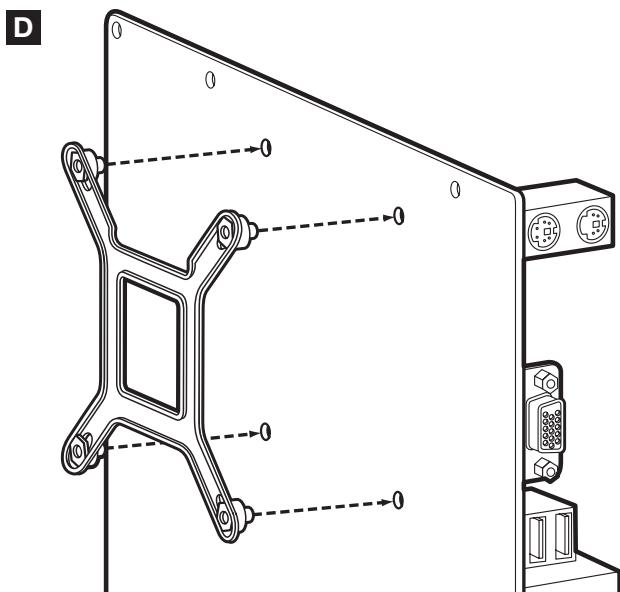

Dostosuj płytę montażową do odpowiedniego gniazda.

Uwaga: W przypadku gniazd procesora Intel LGA 2011, 2011-3 oraz 2066 nie jest konieczne montowanie podstawki.

Przejdź do kroku 2.

2. MONTOWANIE ŚRUB DYSTANSOWYCH INTEL

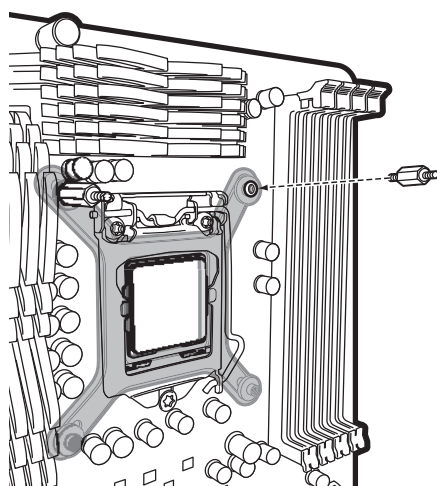

A LGA 1200/1150/
1151/1155/1156

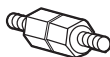

B LGA 2011/
2011-3/2066

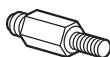

C LGA 1700

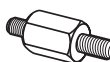

- > Zamocuj śruby dystansowe Intel (w komplecie) w gnieździe.
- > Użyj śrub (A) w przypadku gniazda LGA 1200/115X, (B) w przypadku LGA 2011/2011-3/2066 lub (C) w przypadku LGA 1700.
- > Mocno dokręć wszystkie cztery śruby.

3. MONTOWANIE WENTYLATORÓW I RADIATORA

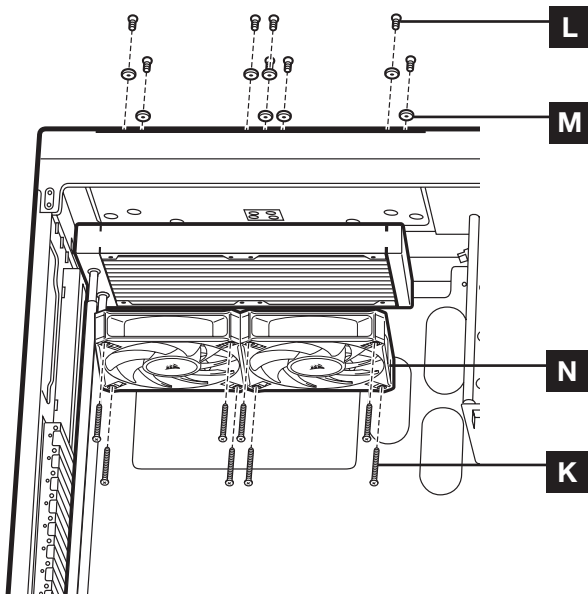

Zamocuj radiator i wentylatory zgodnie z rysunkiem. Aby uzyskać najwyższą wydajność chłodzenia, zalecamy zamontowanie wentylatorów w obudowie komputera jako wlotowych.

4. MONTOWANIE POMPKI

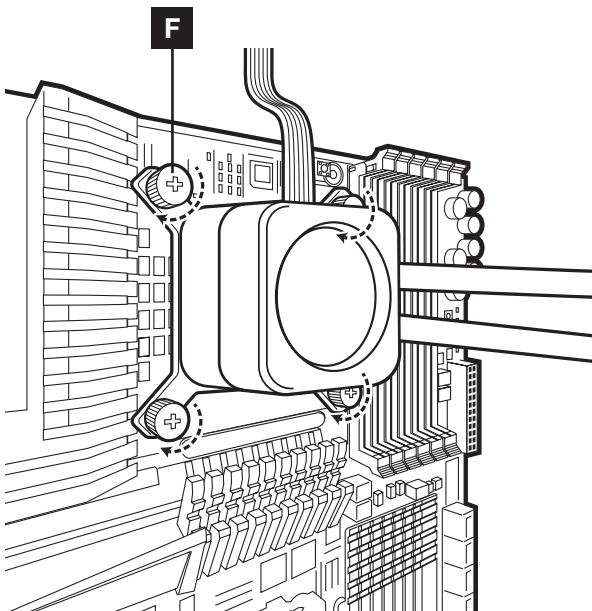







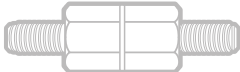
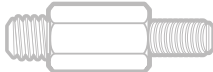

- > Wyrównaj uchwyt i pompkę względem śrub dystansowych zgodnie z rysunkiem.
- > Przykręć śruby radełkowane (F) do śrub dystansowych, jak pokazano to na ilustracji.
- > Mocno dokręć śruby radełkowane w czterech rogach.

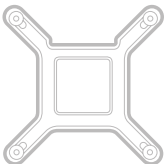
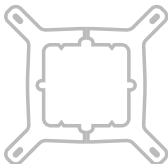
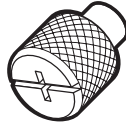
Aby kontynuować instalację, przejdź do strony 10.

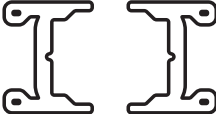
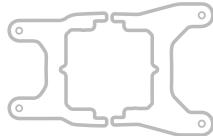
WYPOSAŻENIE

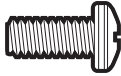
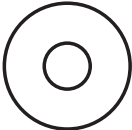
Wyróżnione części dotyczą tylko instalacji produktów do AMD AM5/AM4.

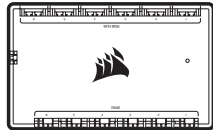
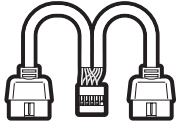
<p>A</p>  <p>x4 ŚRUBY DYSTANSOWE INTEL 1200/1150/1151/1156/1155</p>	<p>B</p>  <p>x4 ŚRUBY DYSTANSOWE INTEL 2011/2011-3/2066</p>	<p>C</p>  <p>x4 ŚRUBY DYSTANSOWE INTEL 1700</p>
<p>D</p>  <p>x1 PODSTAWKA MONTAŻOWA INTEL</p>	<p>E</p>  <p>x1 UCHWYT MOCUJĄCY INTEL (ZAMONTOWANY FABRYCZNIE)</p>	<p>F</p>  <p>x4 ŚRUBY RADEŁKOWANE</p>
<p>G</p>  <p>x4 ŚRUBY DYSTANSOWE AMD AM5/AM4</p>	<p>H</p>  <p>x1 UCHWYT MOCUJĄCY AMD AM5/AM4</p>	<p>I</p>  <p>x1 UCHWYT MOCUJĄCY AMD sTR4/STRX4</p>
<p>J</p>  <p>x4 ŚRUBY DYSTANSOWE AMD sTR4/STRX4</p>	<p>K</p>  <p>x16 DŁUGICH ŚRUB DO WENTYLATORÓW (H100i) x24 DŁUGIE ŚRUBY DO WENTYLATORÓW (H150i/ H170i)</p>	<p>L</p>  <p>x8 ŚRUB DO RADIATORA (H100i) x12 ŚRUB DO RADIATORA (H150i/H170i)</p>
<p>M</p>  <p>x8 PODKŁADEK (H100i) x12 PODKŁADEK (H150i/H170i)</p>	<p>N</p>  <p>x2 WENTYLATORY AF RGB ELITE (H100i) x3 WENTYLATORY AF RGB ELITE (H150i/H170i)</p>	<p>O</p>  <p>COMMANDER CORE</p>
<p>P</p>  <p>ROZDZIELACZ USB</p>		

1. MONTOWANIE UCHWYTU MOCUJĄCEGO AMD AM5/AM4

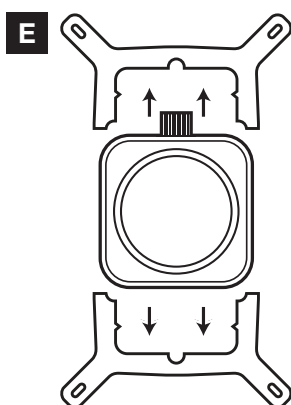

Rysunek 1

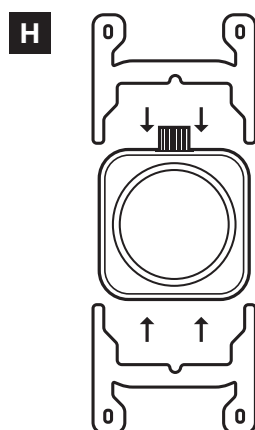

Rysunek 2

- > Zdemontuj przymocowany uchwyt mocujący Intel (rysunek 1).
- > Zamocuj uchwyt AMD AM5/AM4, wpychając z obu stron w gniazdo na pompce (rysunek 2).

Uwaga: Uchwyt mocujący AMD AM5/AM4 należy zamocować stabilnie i równomiernie ze wszystkich stron przed instalacją.

2. MONTOWANIE WENTYLATORÓW I RADIATORA

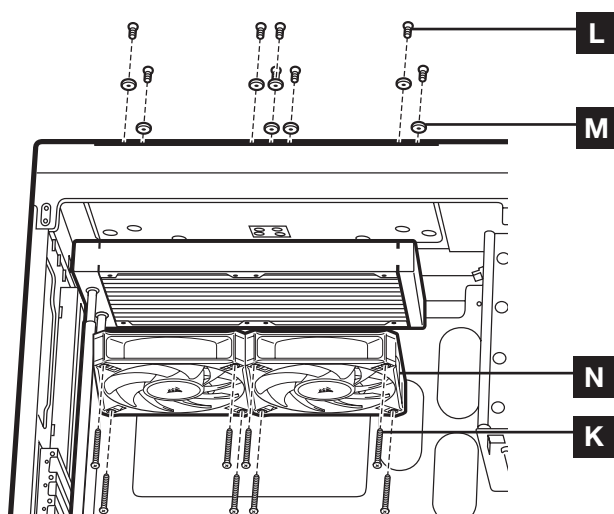

Zamocuj radiator i wentylatory zgodnie z rysunkiem. Aby uzyskać najwyższą wydajność chłodzenia, zalecamy zamontowanie wentylatorów w obudowie komputera jako wlotowych.

3. PRZYGOTUJ PŁYTĘ GŁÓWNA DO INSTALACJI

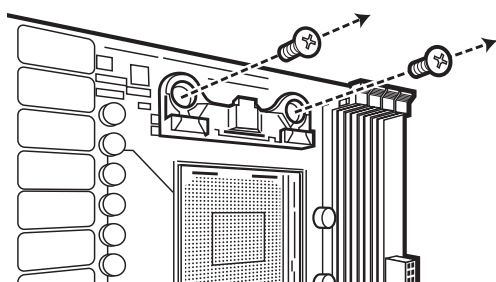

Zdemontuj przymocowane uchwyty mocujące AMD AM5/AM4 zgodnie z rysunkiem.

4. MONTOWANIE ŚRUB DYSTANSOWYCH AMD AM5/AM4

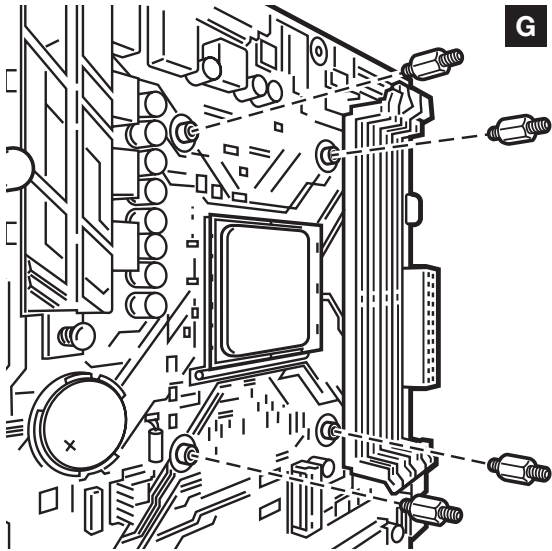

- > Przymocuj śruby dystansowe AMD AM5/AM4 (w komplecie) do gniazda procesora.
- > Mocno dokręć wszystkie cztery śruby.

5. MONTOWANIE POMPKI

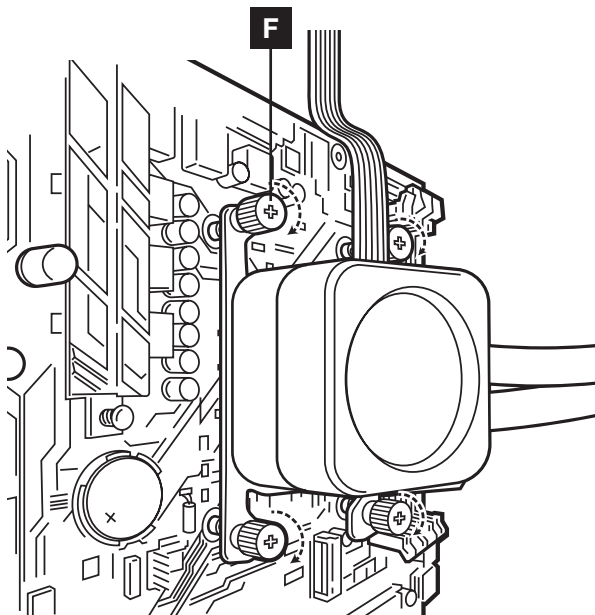







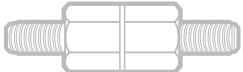

Wyrównaj uchwyt względem śrub dystansowych AMD AM5/AM4 zgodnie z rysunkiem. Mocno dokręć śruby radełkowane (F).

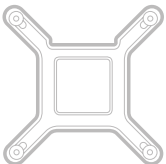
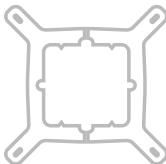
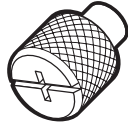
Aby kontynuować instalację, przejdź do strony 10.

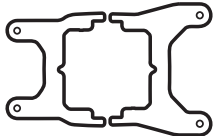
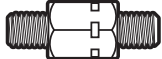
WYPOSAŻENIE

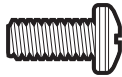
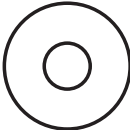
Wyróżnione części dotyczą tylko mocowania do AMD sTRX4

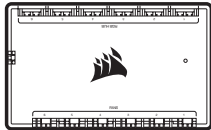
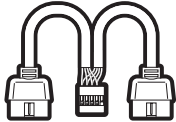
<p>A</p>  <p>x4 ŚRUBY DYSTANSOWE INTEL 1200/1150/1151/1156/1155</p>	<p>B</p>  <p>x4 ŚRUBY DYSTANSOWE INTEL 2011/2011-3/2066</p>	<p>C</p>  <p>x4 ŚRUBY DYSTANSOWE INTEL 1700</p>
<p>D</p>  <p>x1 PODSTAWKA MONTAŻOWA INTEL</p>	<p>E</p>  <p>x1 UCHWYT MOCUJĄCY INTEL (ZAMONTOWANY FABRYCZNIE)</p>	<p>F</p>  <p>x4 ŚRUBY RADEŁKOWANE</p>
<p>G</p>  <p>x4 ŚRUBY DYSTANSOWE AMD AM5/AM4</p>	<p>H</p>  <p>x1 UCHWYT MOCUJĄCY AMD AM5/AM4</p>	<p>I</p>  <p>x1 UCHWYT MOCUJĄCY AMD sTR4/sTRX4</p>
<p>J</p>  <p>x4 ŚRUBY DYSTANSOWE AMD sTR4/sTRX4</p>	<p>K</p>  <p>x16 DŁUGICH ŚRUB DO WENTYLATORÓW (H100i) x24 DŁUGIE ŚRUBY DO WENTYLATORÓW (H150i/ H170i)</p>	<p>L</p>  <p>x8 ŚRUB DO RADIATORA (H100i) x12 ŚRUB DO RADIATORA (H150i/H170i)</p>
<p>M</p>  <p>x8 PODKŁADEK (H100i) x12 PODKŁADEK (H150i/H170i)</p>	<p>N</p>  <p>x2 WENTYLATORY AF RGB ELITE (H100i) x3 WENTYLATORY AF RGB ELITE (H150i/H170i)</p>	<p>O</p>  <p>COMMANDER CORE</p>
<p>P</p>  <p>ROZDZIELACZ USB</p>		

1. Montowanie uchwyty mocującego AMD sTRX4

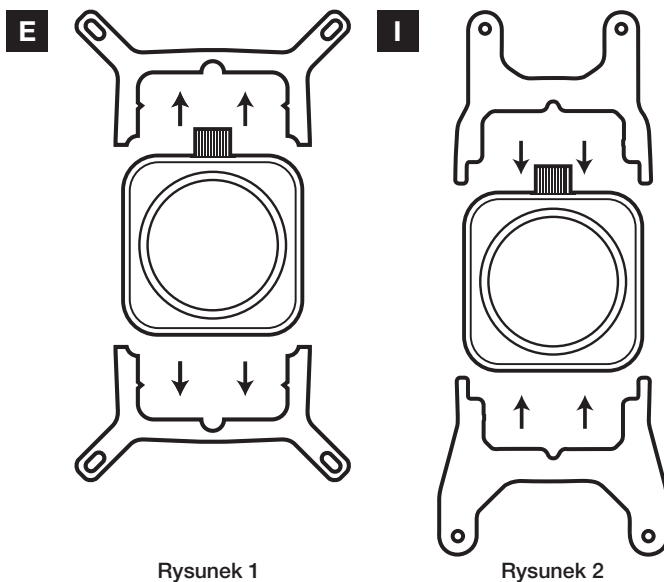

- > Zdemontuj przymocowany uchwyt mocujący Intel (rysunek 1).
- > Zamocuj uchwyt AMD sTRX4, wpychając z obu stron w gniazda na pompce (rysunek 2).

Uwaga: Uchwyt mocujący AMD sTRX4 należy zamocować stabilnie i równomiernie ze wszystkich stron przed instalacją.

2. MONTOWANIE ŚRUB DYSTANSOWYCH AMD sTRX4

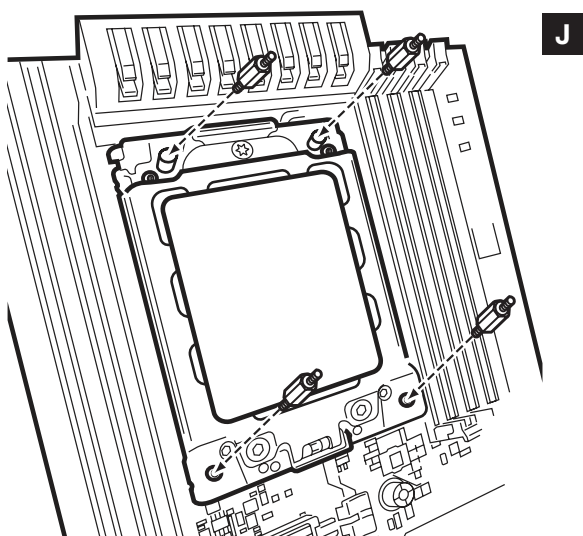

- > Przymocuj śruby dystansowe AMD sTRX4 (w komplecie) do gniazda procesora.
- > Mocno dokręć wszystkie cztery śruby.

3. MONTOWANIE WENTYLATORÓW I RADIATORA

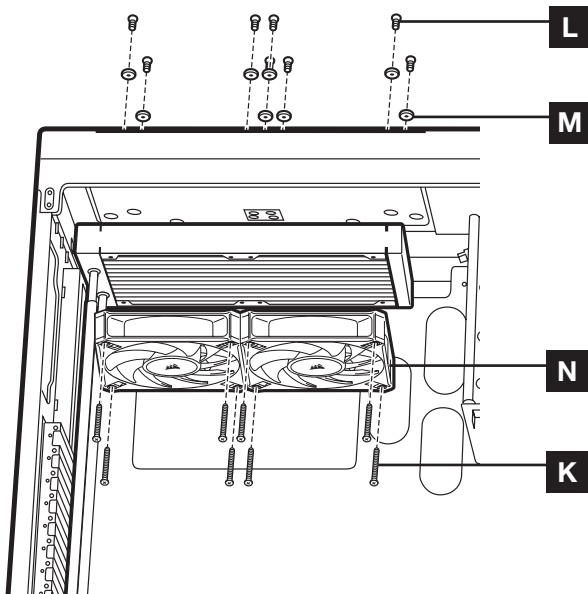

Zamocuj radiator i wentylatory zgodnie z rysunkiem. Aby uzyskać najwyższą wydajność chłodzenia, zalecamy zamontowanie wentylatorów w obudowie komputera jako wlotowych.

4. MONTOWANIE POMPKI

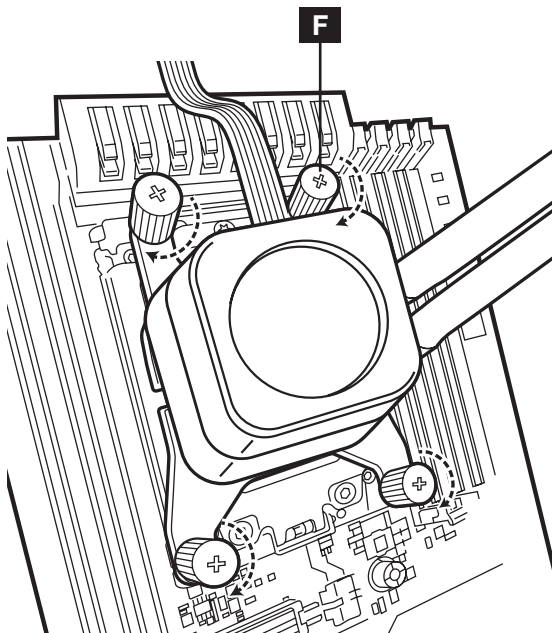

- > Wyrównaj uchwyt i pompkę względem śrub dystansowych zgodnie z rysunkiem.
- > Przykręć śruby radełkowane (F) do śrub dystansowych, jak pokazano to na ilustracji.
- > Mocno dokręć śruby radełkowane w czterech rogach.

Aby kontynuować instalację, przejdź do strony 10.

PODŁĄCZANIE WENTYLATORÓW I POMPKI DO KONTROLERA COMMANDER CORE

- > Podłącz przewód 24-pinowy pompki do kontrolera COMMANDER CORE (rysunek 1).
- > Podłącz przewód tachometru pompki do złącza CPU_FAN na płycie głównej (rysunek 2).
- > Podłącz wszystkie wentylatory do kontrolera COMMANDER CORE (rysunek 3).
- > Podłącz wszystkie przewody RGB wentylatorów do kontrolera COMMANDER CORE (rysunek 3).

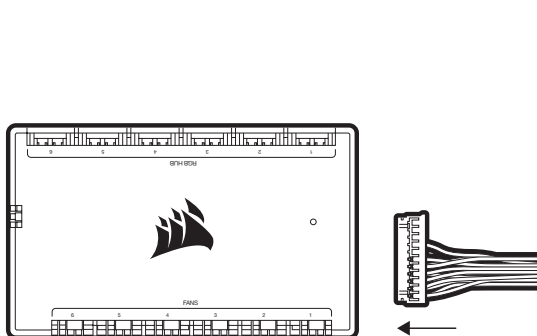

Rysunek 1

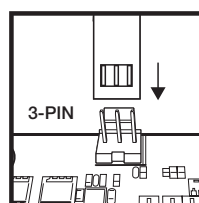

Rysunek 2

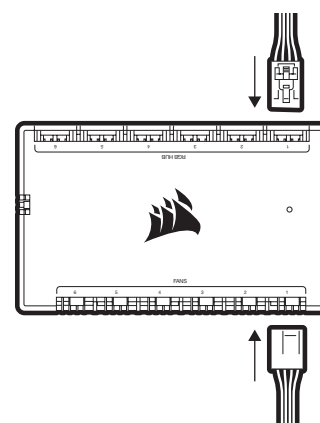

Rysunek 3

PODŁĄCZANIE KONTROLERA COMMANDER CORE I MODUŁU ELITE LCD XT DO ZŁĄCZA USB 2.0 I ZASILANIA

- > Podłącz kontroler COMMANDER CORE do gniazda USB 2.0 na płycie głównej dodanym w komplecie przewodem USB.
- > Połącz przewód zasilający pompki z dostępną wtyczką zasilania SATA z zasilacza.
- > Dzięki dołączonemu rozgałęziaczowi USB można zmniejszyć liczbę wymaganych portów USB z dwóch do jednego.

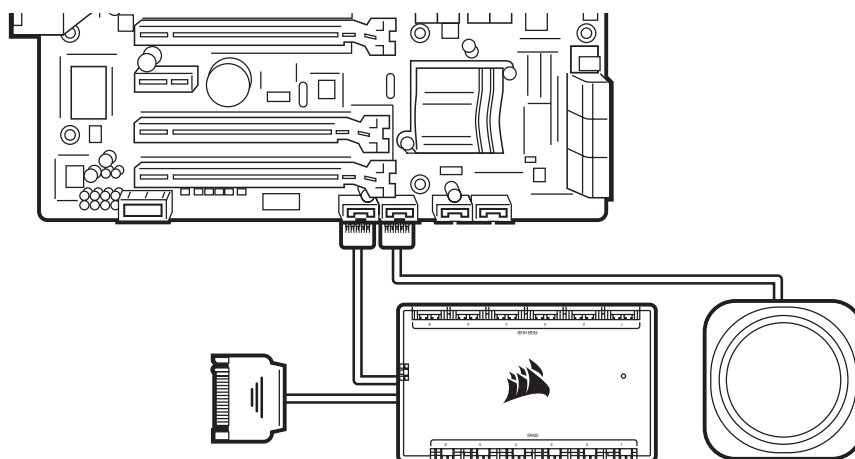

CZĘSTO ZADAWANE PYTANIA

1. Skąd wiadomo, jaki jest kierunek przepływu powietrza przez wentylator?

Kierunek przepływu powietrza wskazuje strzałka znajdująca się z boku wentylatora.

2. Czy w przypadku ponownego montażu układu chłodzącego można wykorzystać nałożoną fabrycznie pastę termoprzewodzącą?

Przed ponownym montażem układu chłodzenia należy usunąć nałożoną fabrycznie pastę termoprzewodzącą i nałożyć pastę termoprzewodzącą XTM70 (do nabycia osobno).

3. W jakim ustawieniu należy zamontować radiator?

Radiator można zamontować w dowolnej pozycji, w tym także na odwrót, pod warunkiem że najwyższy punkt radiatora znajduje się wyraźnie wyżej niż pompka procesora, chociaż najlepiej, gdy rurki radiatora znajdują się na dole obudowy.

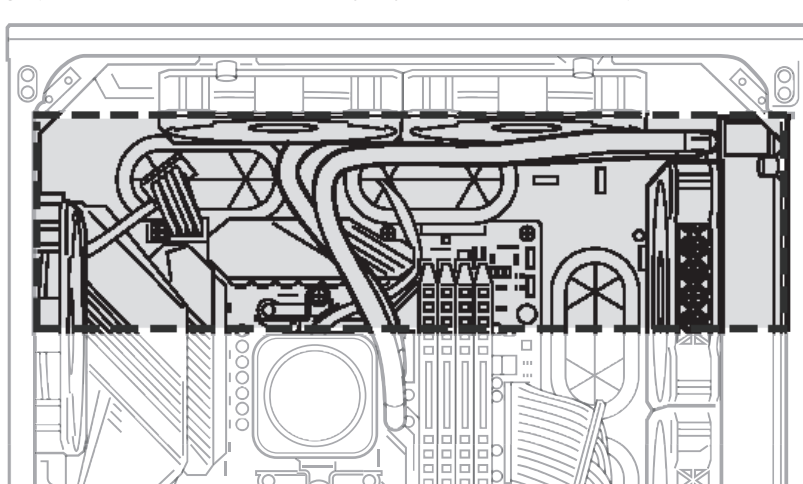

4. Moje wentylatory i układ chłodzenia migają na czerwono i nie działają. Co robić?

Dokładnie sprawdź wszystkie połączenia wentylatorów i układu chłodzenia z COMMANDER CORE. Za pomocą iCUE sprawdź, czy COMMANDER CORE i moduł LCD mają zainstalowane najnowsze oprogramowanie układowe. Jeśli to nie rozwiązuje problemu, wyślij zgłoszenie na stronie support.corsair.com lub skontaktuj się z naszą pomocą techniczną, aby uzyskać dalszą pomoc.

<https://help.corsair.com/hc/en-us/requests/new>

5. Co zrobić, jeśli płytkę montażową układu chłodzenia wydaje się obluzowana po zainstalowaniu?

Po pierwszym zainstalowaniu na płycie głównej płytkę montażową układu chłodzenia często sprawia wrażenie obluzowanej. Po osadzeniu i dociśnięciu pompka dociągnie płytkę montażową do płyty głównej i wyrzuci nacisk na gniazdo za pośrednictwem układu chłodzenia.

WAŻNE: NIGDY nie dodawaj podkładek do płytki montażowej w celu zmniejszenia luzu. Zwiększy to nacisk na zestaw montażowy, co może spowodować uszkodzenie tego zestawu, płyty głównej lub gniazda.

简体中文

注意: 大多数新近推出的 PC 机箱都包含一个 CPU 开口, 以便进入主板底部。如果您的机箱没有开口, 则需要在机箱安装之前卸下主板。ELITE LCD XT 冷却器随附已预先安装在泵上的 Intel 安装支架, 以便快速安装。

目录

INTEL (所有插槽)

AMD AM5/AM4

AMD sTRX4

安装







常见问题

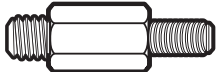
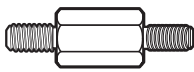
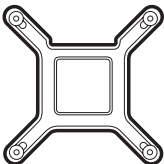
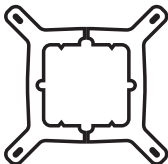
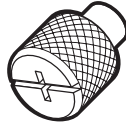

请确保在安装前关闭整个 PC 的电源。LCD 模块、泵和 COMMANDER CORE 对热插拔和 ESD 敏感。

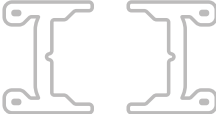
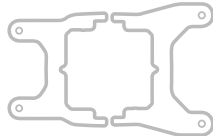
随附硬件

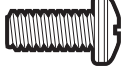
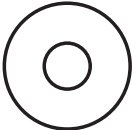
突出显示的部件仅适用于安装在 Intel 上

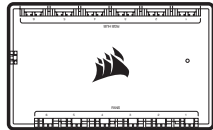
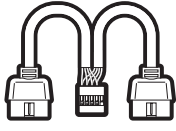
<p>A</p>  <p>x4 INTEL 1200/1150/1151/1156/1155 压铆螺柱</p>	<p>B</p>  <p>x4 INTEL 2011/2011-3/2066 压铆螺柱</p>	<p>C</p>  <p>x4 INTEL 1700 压铆螺柱</p>
<p>D</p>  <p>x1 INTEL 背板</p>	<p>E</p>  <p>x1 INTEL 安装支架 (预先安装)</p>	<p>F</p>  <p>x4 指旋螺丝</p>
<p>G</p>  <p>x4 AMD AM5/AM4 压铆螺柱</p>	<p>H</p>  <p>x1 AMD AM5/AM4 安装支架</p>	<p>I</p>  <p>x1 AMD sTR4/sTRX4 安装支架</p>
<p>J</p>  <p>x4 AMD sTR4/sTRX4 压铆螺柱</p>	<p>K</p>  <p>x16 风扇长螺丝 (H100i) x24 风扇长螺丝 (H150i/H170i)</p>	<p>L</p>  <p>x8 散热器螺丝 (H100i) x12 散热器螺丝 (H150i/H170i)</p>
<p>M</p>  <p>x8 垫圈 (H100i) x12 垫圈 (H150i/H170i)</p>	<p>N</p>  <p>x2 AF RGB ELITE 风扇 (H100i) x3 AF RGB ELITE 风扇 (H150i/H170i)</p>	<p>O</p>  <p>COMMANDER CORE</p>
<p>P</p>  <p>USB Y 型分路器</p>		

1. 安装 INTEL 背板

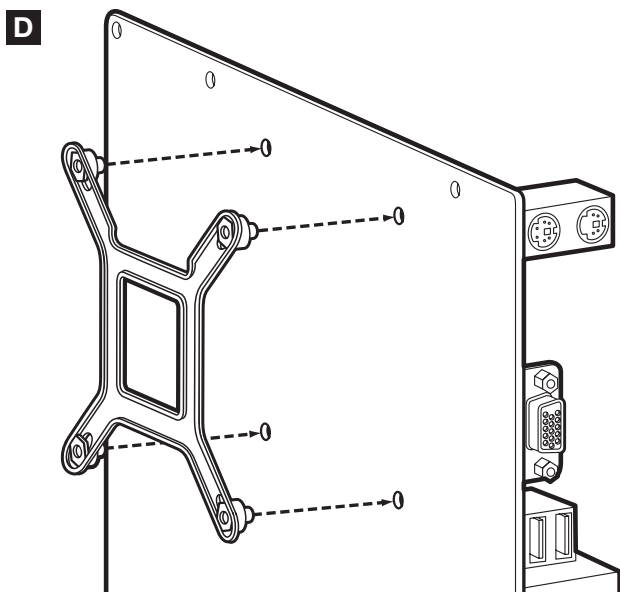

根据所需的插槽调整背板。

注意: Intel LGA 2011/2011-3/2066 无需安装背板。
继续执行步骤2。

2. 安装适用于 INTEL 的压铆螺柱螺丝

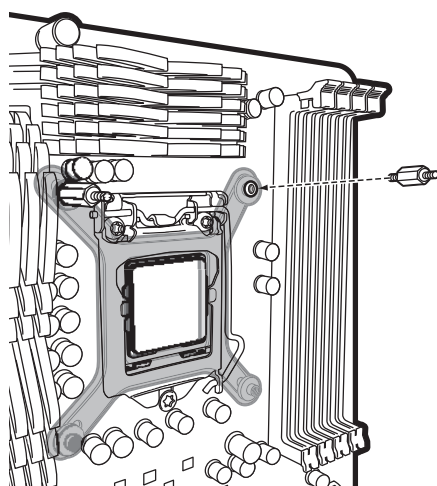

A LGA 1200/1150/
1151/1155/1156



B LGA 2011/
2011-3/2066



C LGA 1700

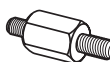

- > 为您的插槽安装随附的 Intel 压铆螺柱。
- > 将 (A) 用于 LGA 1200/115X、(B) 用于 LGA 2011/2011-3/2066 或 (C) 用于 LGA 1700。
- > 将四颗螺丝全部拧紧，直到紧固。

3. 安装风扇和散热器

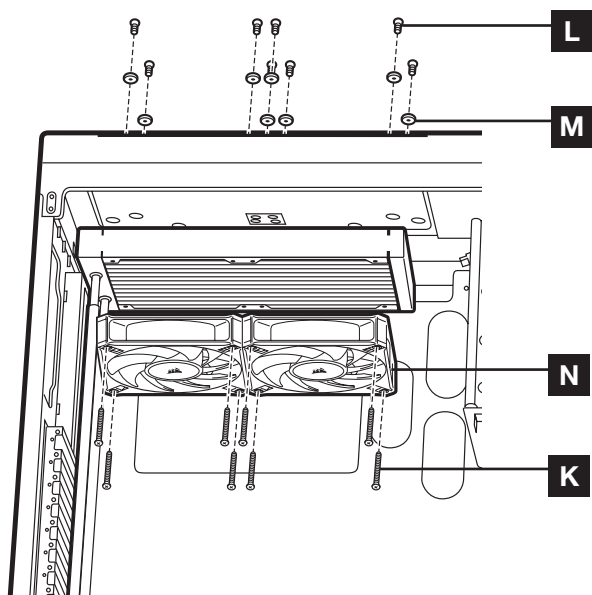

安装散热器和风扇，如图所示。为了获得更好的冷却效果，我们建议将其作为进气风扇安装到 PC 机箱中。

4. 安装泵装置

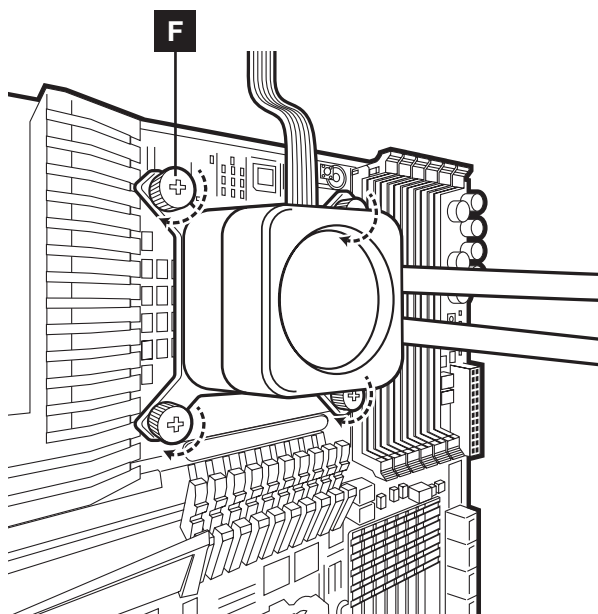







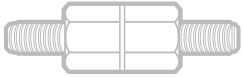

- > 通过压铆螺柱螺丝让支架和泵对准，如图所示。
- > 将指旋螺丝 (F) 安装到压铆螺柱螺丝，如图所示。
- > 拧紧指旋螺丝，直到四颗螺丝全部紧固。

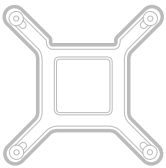
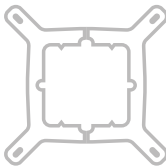
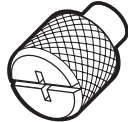
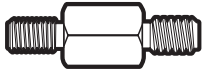
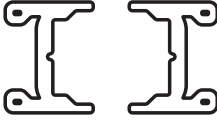
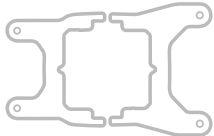
要继续安装，请前往第 10 页。

随附硬件

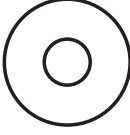
突出显示的部件仅适用于安装 AMD AM5/AM4

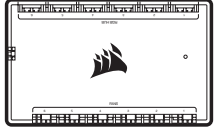
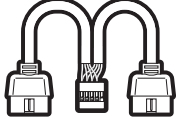
<p>A</p>  <p>x4 INTEL 1200/1150/1151/1156/1155 压铆螺柱</p>	<p>B</p>  <p>x4 INTEL 2011/2011-3/2066 压铆螺柱</p>	<p>C</p>  <p>x4 INTEL 1700 压铆螺柱</p>
<p>D</p>  <p>x1 INTEL 背板</p>	<p>E</p>  <p>x1 INTEL 安装支架 (预先安装)</p>	<p>F</p>  <p>x4 指旋螺丝</p>
<p>G</p>  <p>x4 AMD AM5/AM4 压铆螺柱</p>	<p>H</p>  <p>x1 AMD AM5/AM4 安装支架</p>	<p>I</p>  <p>x1 AMD sTR4/sTRX4 安装支架</p>
<p>J</p>  <p>x4 AMD sTR4/sTRX4 压铆螺柱</p>	<p>K</p>  <p>x16 风扇长螺丝 (H100i) x24 风扇长螺丝 (H150i/H170i)</p>	<p>L</p>  <p>x8 散热器螺丝 (H100i) x12 散热器螺丝 (H150i/H170i)</p>
<p>M</p>  <p>x8 垫圈 (H100i) x12 垫圈 (H150i/H170i)</p>	<p>N</p>  <p>x2 AF RGB ELITE 风扇 (H100i) x3 AF RGB ELITE 风扇 (H150i/H170i)</p>	<p>O</p>  <p>COMMANDER CORE</p>
<p>P</p>  <p>USB Y 型分路器</p>		

1. 安装 AMD AM5/AM4 安装支架

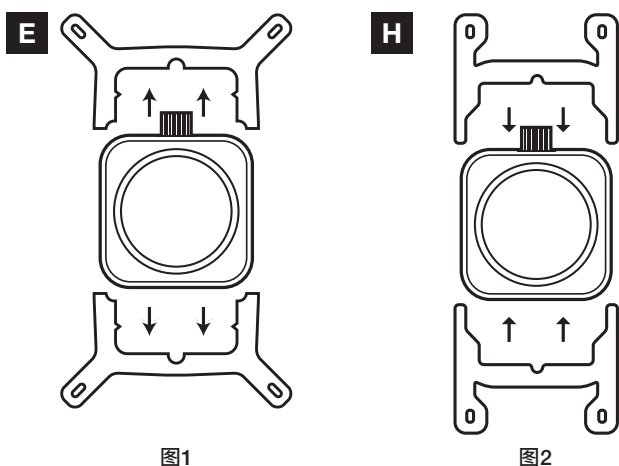

- > 将集成的 Intel 安装支架卸下 (图1)。
- > 安装 AMD AM5/AM4 支架时, 将支架的两侧压入泵上的插槽, 直到紧固 (图2)。

注意: 重要提示, 安装前, 请确保 AMD AM5/AM4 固定支架的每一侧都已稳固。

2. 安装风扇和散热器

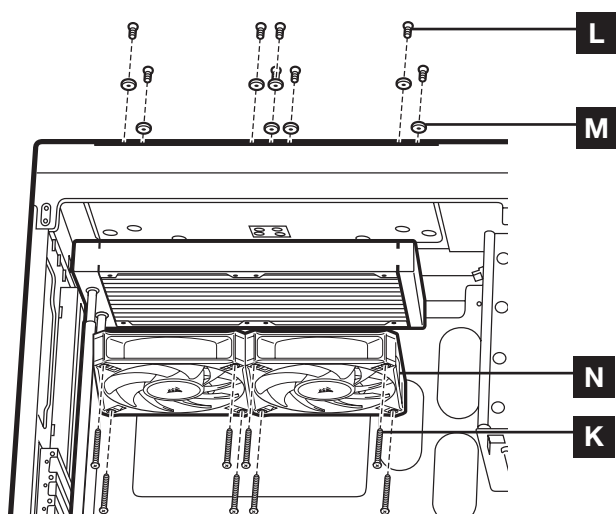

安装散热器和风扇, 如图所示。为了更好的冷却效果, 我们建议将其作为进气风扇安装到 PC 机箱中。

3. 准备主板用于安装

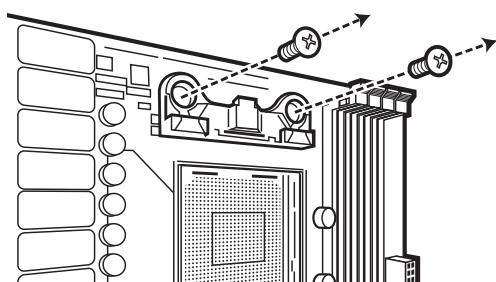

移除所示的现有 AMD AM5/AM4 安装支架。

4. 安装 AMD AM5/AM4 压铆螺柱螺丝

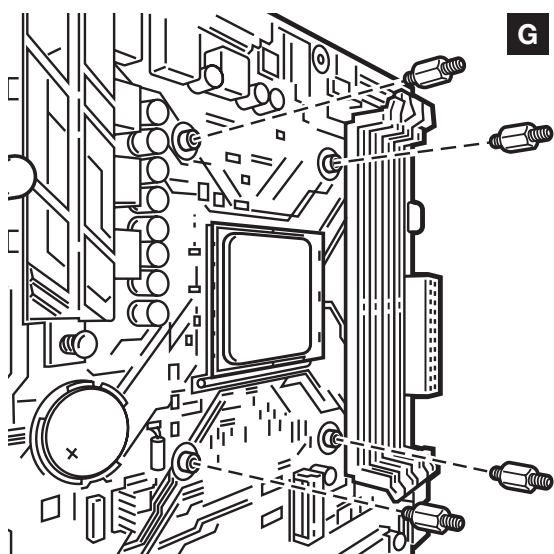

- > 将随附的 AMD AM5/AM4 压铆螺柱安装到 CPU 插槽。
- > 拧紧全部四颗螺丝, 直到紧固。

5. 安装泵装置

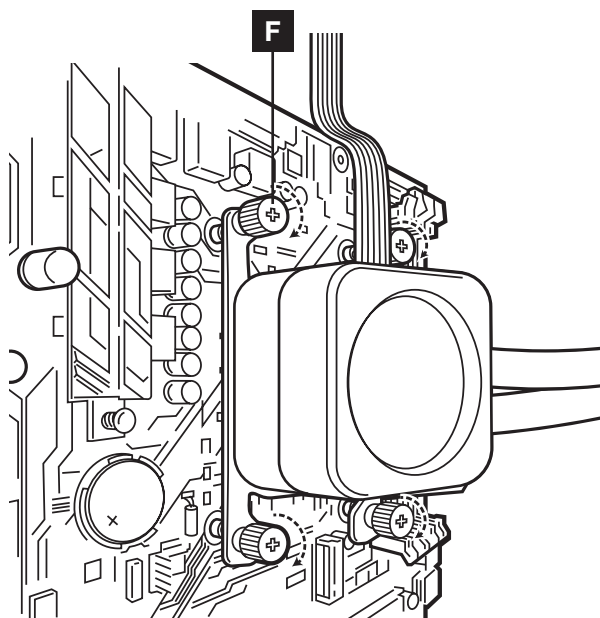







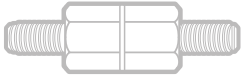

将支架与 AMD AM5/AM4 压铆螺柱对齐, 如图所示。拧紧指旋螺丝 (F) 直到紧固。

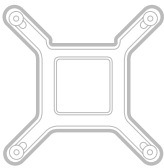
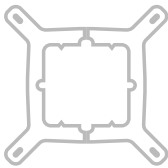
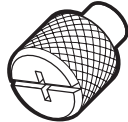
要继续安装, 请前往第 10 页。

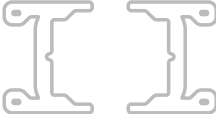
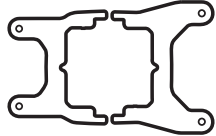
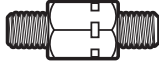
随附硬件

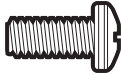
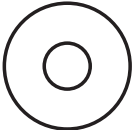
突出显示的部件仅适用于安装 AMD sTRX4

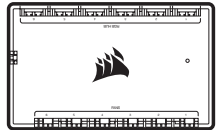
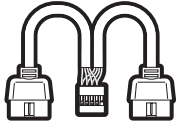
<p>A</p>  <p>x4 INTEL 1200/1150/1151/1156/1155 压铆螺柱</p>	<p>B</p>  <p>x4 INTEL 2011/2011-3/2066 压铆螺柱</p>	<p>C</p>  <p>x4 INTEL 1700 压铆螺柱</p>
<p>D</p>  <p>x1 INTEL 背板</p>	<p>E</p>  <p>x1 INTEL 安装支架 (预先安装)</p>	<p>F</p>  <p>x4 指旋螺丝</p>
<p>G</p>  <p>x4 AMD AM5/AM4 压铆螺柱</p>	<p>H</p>  <p>x1 AMD AM5/AM4 安装支架</p>	<p>I</p>  <p>x1 AMD sTR4/sTRX4 安装支架</p>
<p>J</p>  <p>x4 AMD sTR4/sTRX4 压铆螺柱</p>	<p>K</p>  <p>x16 风扇长螺丝 (H100i) x24 风扇长螺丝 (H150i/H170i)</p>	<p>L</p>  <p>x8 散热器螺丝 (H100i) x12 散热器螺丝 (H150i/H170i)</p>
<p>M</p>  <p>x8 垫圈 (H100i) x12 垫圈 (H150i/H170i)</p>	<p>N</p>  <p>x2 AF RGB ELITE 风扇 (H100i) x3 AF RGB ELITE 风扇 (H150i/H170i)</p>	<p>O</p>  <p>COMMANDER CORE</p>
<p>P</p>  <p>USB Y 型分路器</p>		

1. 安装 AMD sTRX4 安装支架



图1

图2

- > 将集成的 Intel 安装支架卸下 (图1)。
- > 安装 AMD sTRX4 支架时, 将支架的两侧压入泵上的插槽, 直到紧固 (图2)。

注意: 重要提示, 安装前, 请确保 AMD sTRX4 固定支架的每一侧都已稳固。

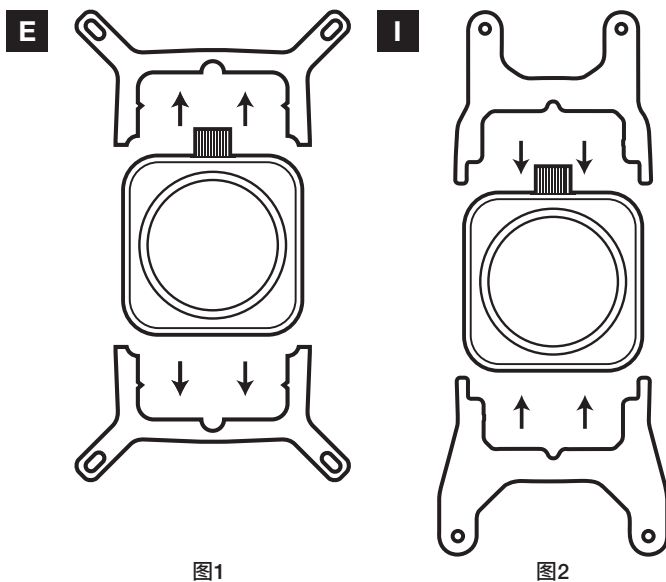
2. 安装 AMD sTRX4 压铆螺柱螺丝

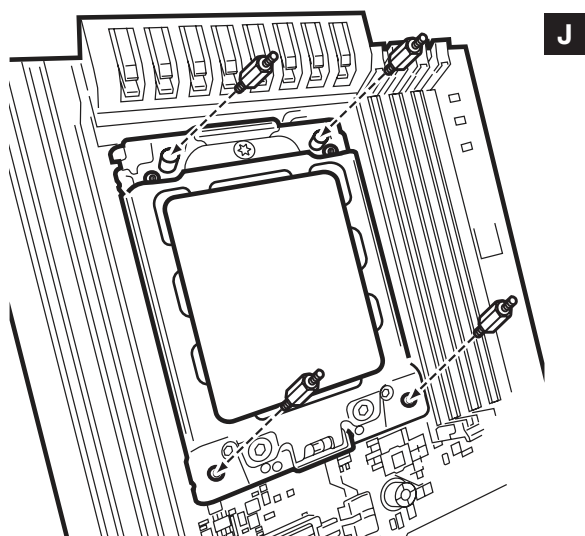

- > 将随附的 AMD sTRX4 压铆螺柱安装到 CPU 插槽。
- > 拧紧全部四颗螺丝, 直到紧固。

3. 安装风扇和散热器

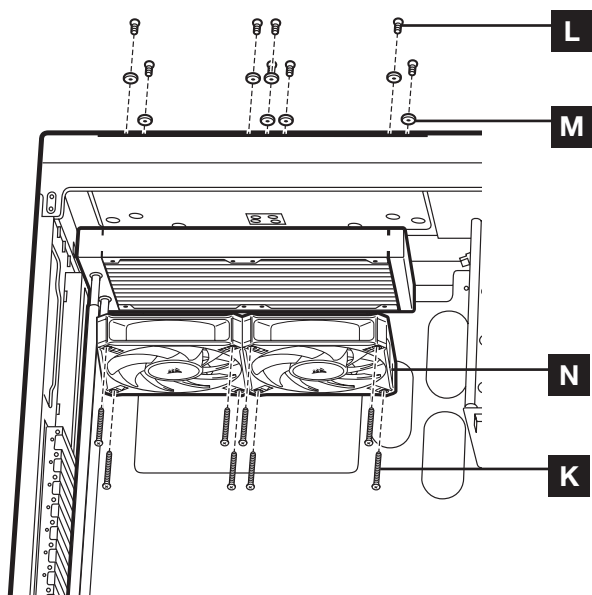

安装散热器和风扇, 如图所示。为了更好的冷却效果, 我们建议将其作为进气风扇安装到 PC 机箱中。

4. 安装泵装置

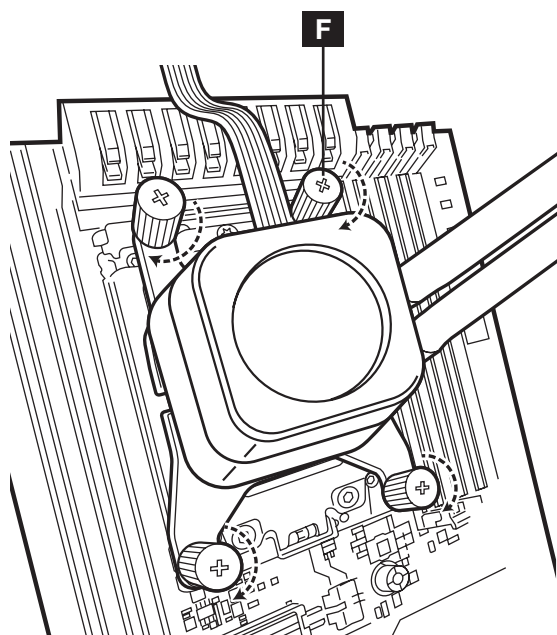

- > 通过压铆螺柱螺丝让支架和泵对准, 如图所示。
- > 将指旋螺丝(F)安装到压铆螺柱螺丝, 如图所示。
- > 拧紧指旋螺丝, 直到四颗螺丝全部紧固。

要继续安装, 请前往第 10 页。

将风扇和泵连接到 COMMANDER CORE

- > 将泵的 24 引脚线缆连接到 COMMANDER CORE (图1)。
- > 将泵上带扣的线缆连接至主板上的 CPU_FAN 接头 (图2)。
- > 将各个风扇连接到 COMMANDER CORE (图3)。
- > 将各个风扇的 RGB 线缆连接到 COMMANDER CORE (图3)。



图1



图2

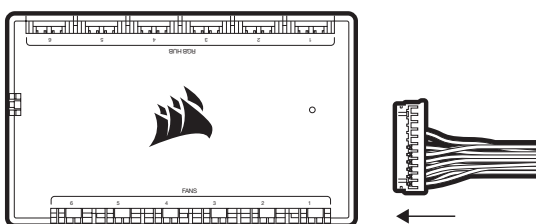

图3

将 COMMANDER CORE 和 ELITE LCD XT 模块连接到 USB 2.0 接头和电源

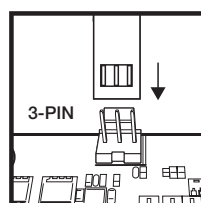
- > 使用随附的 USB 线缆, 将 COMMANDER CORE 连接到主板上的 USB 2.0 接头。
- > 将泵电源线从电源连接至可用 SATA 电源插头。
- > 使用随附的 USB Y 型分路器可以将所需的 USB 端口从 2 个缩减为 1 个。

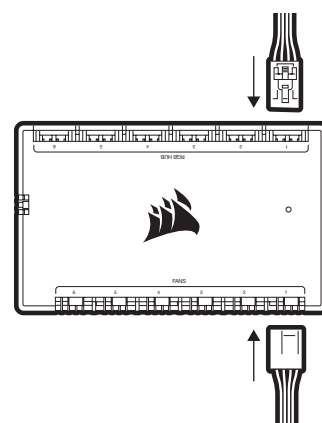
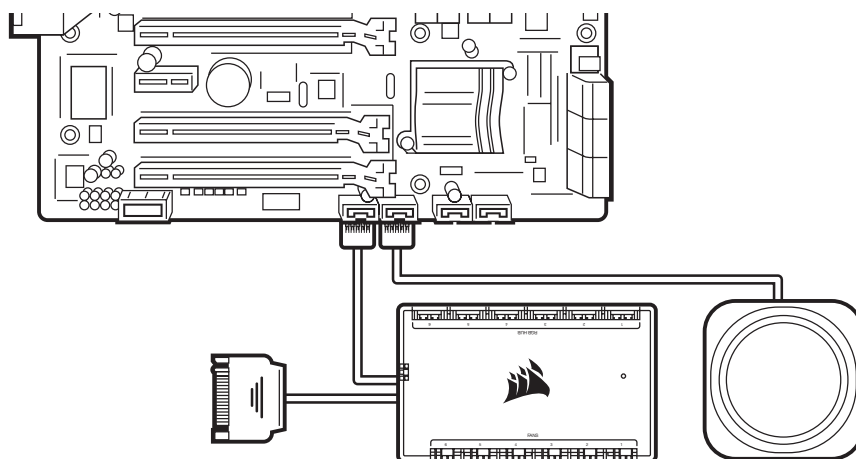

常见问题

1. 我如何才能知道风扇的气流方向？

风扇侧边的箭头会指示气流的方向。

2. 重新安装时，能否重复使用预先涂抹的导热膏脂？

重新安装冷却器时，需要清除预涂抹的导热膏脂，然后重新涂抹 XTM70 导热膏脂（需单独购买）。

3. 我应该朝哪个方向安装散热器？

安装散热器的一个好方法就是将管道置于机箱的底部，当然您也可以在任何位置安装散热器，即使是倒置的散热器也可以，只要散热器的高点明显高于 CPU 泵即可。

4. 我的冷却器和风扇闪烁红光或无法正常工作。我该怎么办？

请仔细检查冷却器和风扇与 COMMANDER CORE 的所有连接。请确保 COMMANDER CORE 和 LCD 模块都已经通过 iCUE 更新到新固件。如果这不能解决您的问题，请在 support.corsair.com 创建请求，或者联系我们的客户支持团队，进一步排除故障并寻求协助。

<https://help.corsair.com/hc/en-us/requests/new>

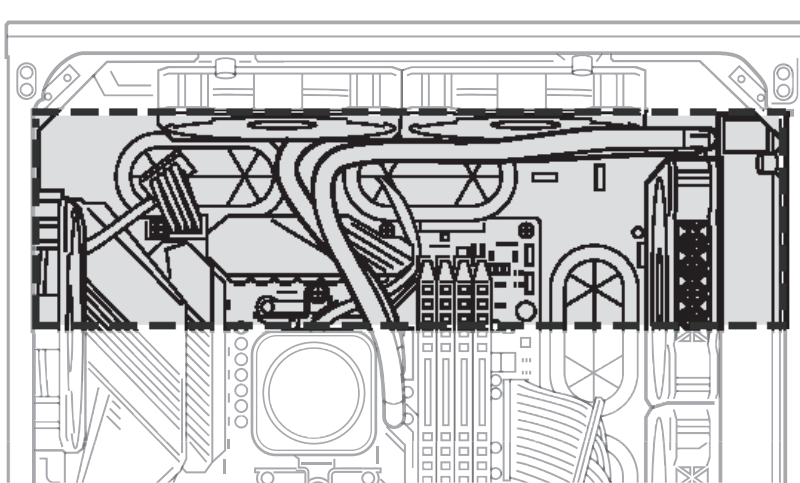

5. 如果安装后感觉冷却器背板松动，该如何处理？

首次安装到主板后，感到冷却器背板松动是正常现象。冷却器泵被固定并紧固后，会将背板拉向主板，并通过冷却器对插槽施加压力。

重要提示：在任何情况下，都不要向背板额外添加垫圈和垫片来减少背板上的间隙。这样做会增加固定套件的安装压力，并有可能损坏固定套件、主板或插槽。

ملحوظة: تتضمن معظم علب الكمبيوتر الحديثة فتحة في وحدة المعالجة المركزية للسماح بالوصول إلى الجانب السفلي من اللوحة الأم. إذا كانت العلبة الخاصة بك لا تتضمن فتحة، فستحتاج إلى إزالة اللوحة الأم الخاصة بك من العلبة قبل التركيب. تأتي مبرّدات ELITE LCD XT مزودةً بكتيفة تثبيت من Intel تم تركيبها مسبقًا على المضخة بهدف التركيب السريع.

تايوت حمل لودج

INTEL (جميع المقابس)

AMD AM5/AM4

AMD sTRX4

التركيب

الأسئلة المتكررة











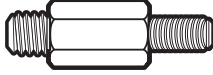

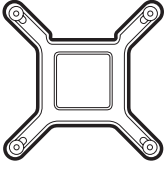
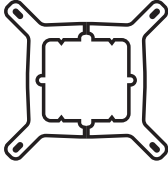
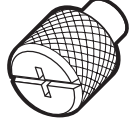
يُرجى التأكد من فصل الطاقة عن الكمبيوتر بأكمله قبل التركيب. فوحدة LCD، المضخة، و
COMMANDER CORE حساسون للتوصيل أثناء التشغيل والتفريغ الإلكترونياتيك.

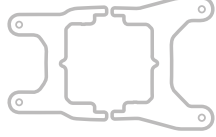

الأجهزة المضمنة

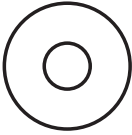
عناصر مخصصة لت تركيبات Intel فقط

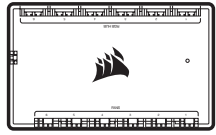
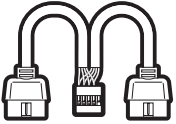
<p>A</p>  <p>4 مبادعات من نوع INTEL 1200/1150/1151/1156/1155</p>	<p>B</p>  <p>4 مبادعات من نوع INTEL 2011/2011-3/2066</p>	<p>C</p>  <p>4 مبادعات من نوع INTEL 1700</p>
<p>D</p>  <p>لوحة خلفية واحدة من INTEL</p>	<p>E</p>  <p>كثيفة تثبيت واحدة من INTEL (تم تركيبها مسبقاً)</p>	<p>F</p>  <p>4 براغي لولبية</p>
<p>G</p>  <p>4 مبادعات من النوع AMD AM5/AM4</p>	<p>H</p>  <p>كثيفة تثبيت واحدة من النوع AMD AM5/AM4</p>	<p>I</p>  <p>كثيفة تثبيت واحدة من النوع AMD sTR4/STRX4</p>
<p>J</p>  <p>4 مبادعات من النوع AMD sTR4/STRX4</p>	<p>K</p>  <p>16 برغماً طويلاً للمروحة (H100i) 24 برغماً طويلاً للمروحة (H150i/H170i)</p>	<p>L</p>  <p>8 براغي للمبرد (H100i) 12 برغماً للمبرد (H150i/H170i)</p>
<p>M</p>  <p>8 فلكات (H100i) 12 فلكة (H150i/H170i)</p>	<p>N</p>  <p>2 مروحتان (H100i) AF RGB ELITE 3 مراوح (H150i/H170i) AF RGB ELITE FANS</p>	<p>O</p>  <p>COMMANDER CORE</p>
<p>P</p>  <p>وحدة توزيع Y للتوصيل عبر USB</p>		

1. تركيب اللوحة الخلفية من INTEL

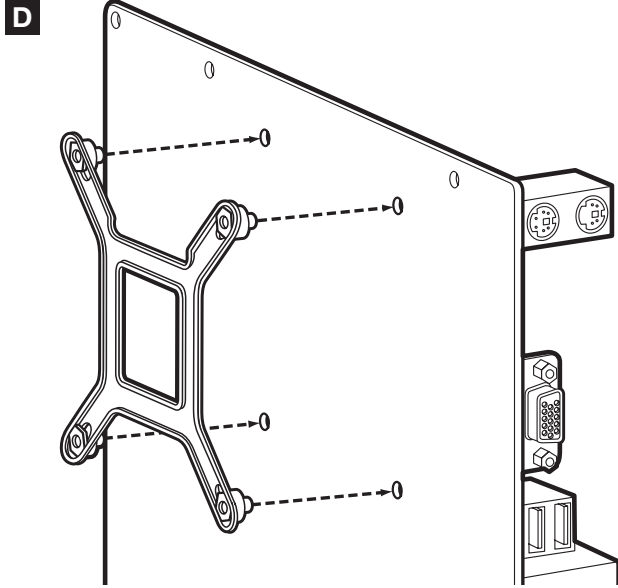

اضبط اللوحة الخلفية بمقبسك المطلوب.

ملحوظة: لا تحتاج الأنواع -LGA 2011/2011-3/2066 من Intel إلى تركيب اللوحة الخلفية. تابع إلى الخطوة 2.

2. تركيب براغي المبعاد من INTEL

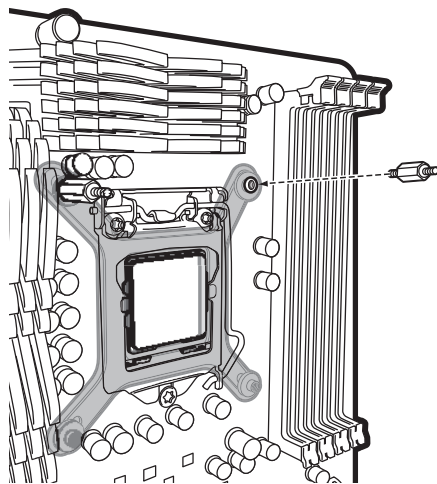

A LGA 1200/1150/
1151/1155/1156

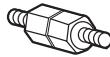

B LGA 2011/
2011-3/2066

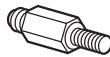

C LGA 1700



< صل مبعاد Intel المرفق الخاص بالمقبس.
< استخدم (A) للنوع LGA 1200/115X أو (B)
للنوع LGA 2011/2011-3/2066 أو (C)
للنوع LGA 1700.
< أحكم ربط كل البراغي الأربعة حتى يتم تثبيتها
بشكل محكم.

3. تركيب المراوح والمبرد

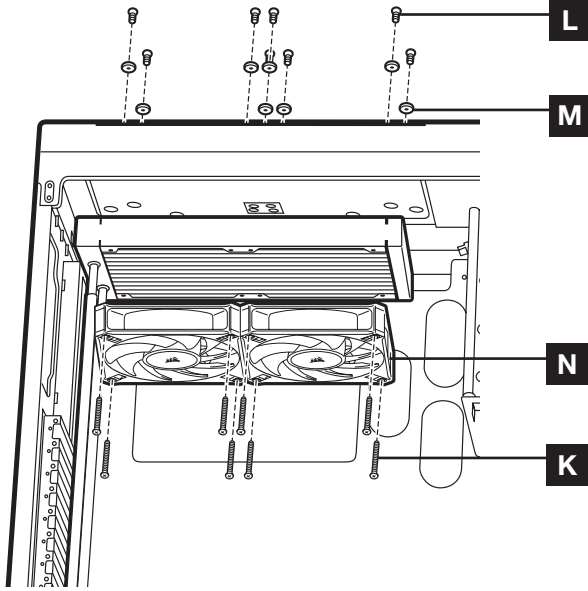





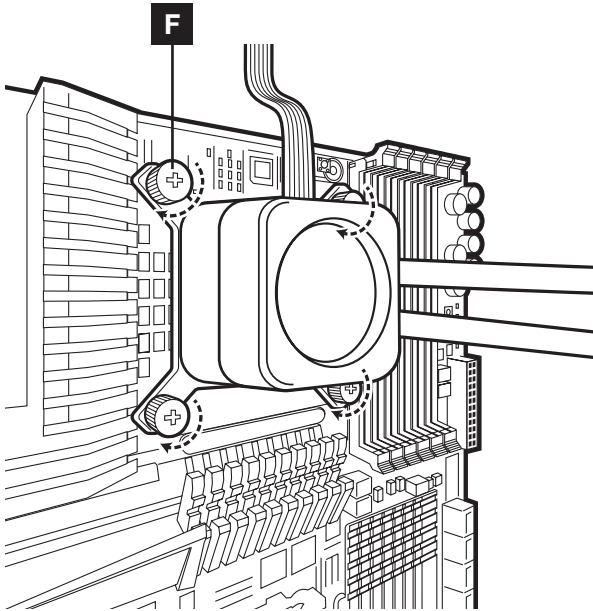



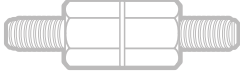

قم بتوصيل المبرد والمراوح كما هو موضح. للحصول على أفضل أداء للتبريد، نوصي بتثبيت المراوح كمدخل هواء بعلبة الكمبيوتر الخاصة بك.

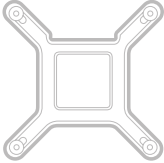
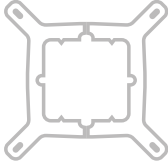
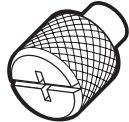
4. تركيب وحدة المضخة

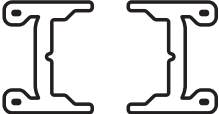
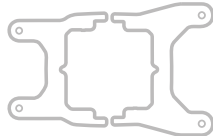

- < اجعل الكتيفة بمحاذاة المضخة على براغي المبعاد كما هو موضح.
- < ركب الصواميل الإبهامية (F) ببراعي المبعاد كما هو موضح.
- < أحكم ربط البراعي الإبهامية حتى يتم تثبيت كل الزوايا الأربع تمامًا.

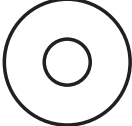
يُرجى المتابعة إلى الصفحة رقم 10 لمتابعة التركيب.

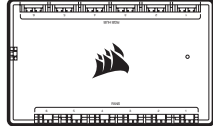
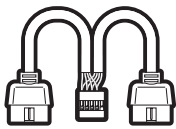
<p>A</p>  <p>4 مبادعات من نوع INTEL 1200/1150/1151/1156/1155</p>	<p>B</p>  <p>4 مبادعات من نوع INTEL 2011/2011-3/2066</p>	<p>C</p>  <p>4 مبادعات من نوع INTEL 1700</p>
<p>D</p>  <p>لوحة خلفية واحدة من INTEL</p>	<p>E</p>  <p>كثيفة تثبيت واحدة من INTEL (تم تركيبها مسبقاً)</p>	<p>F</p>  <p>4 براغي لولبية</p>
<p>G</p>  <p>4 مبادعات من النوع AMD AM5/AM4</p>	<p>H</p>  <p>كثيفة تثبيت واحدة من النوع AMD AM5/AM4</p>	<p>I</p>  <p>كثيفة تثبيت واحدة من النوع AMD sTR4/STRX4</p>
<p>J</p>  <p>4 مبادعات من النوع AMD sTR4/STRX4</p>	<p>K</p>  <p>16 برغماً طويلاً للمروحة (H100i) 24 برغماً طويلاً للمروحة (H150i/H170i)</p>	<p>L</p>  <p>8 براغي للمبرد (H100i) 12 برغماً للمبرد (H150i/H170i)</p>
<p>M</p>  <p>8 فلكات (H100i) 12 فلكة (H150i/H170i)</p>	<p>N</p>  <p>2 مروحتان (H100i) AF RGB ELITE 3 مراوح (H150i/H170i) AF RGB ELITE FANS</p>	<p>O</p>  <p>COMMANDER CORE</p>
<p>P</p>  <p>وحدة توزيع Y للتوصيل عبر USB</p>		

1. تركيب كتيفة التثبيت من النوع AMD AM5/AM4

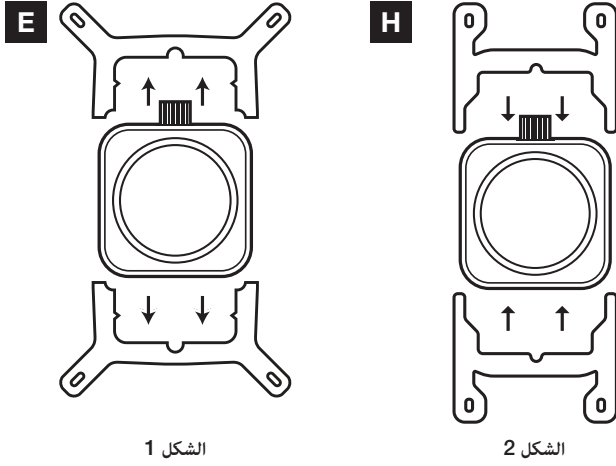

< أزل كتيفة التثبيت المدمجة من Intel (الشكل 1).
 < ركب كتيفة AM5/AM4 عن طريق إدخال كلا الجانبين في الفتحة الموجودة على المضخة حتى يتم تثبيتهما بإحكام (الشكل 2).

ملحوظة: من المهم عدم إحكام ربط كتيفة الاحتجاز AM5/AM4 من AMD تمامًا على جميع الجوانب قبل التركيب.

2. تركيب المراوح والمبرد

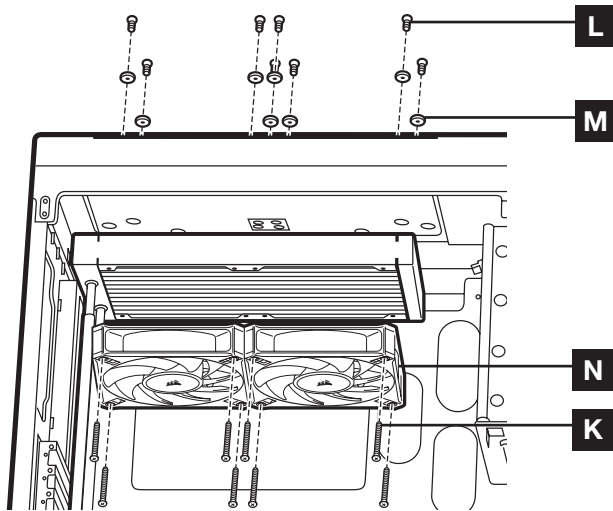

قم بتوصيل المبرد والمراوح كما هو موضح. للحصول على أفضل أداء للتبريد، نوصي بتثبيت المراوح كمدخل هواء بعلبة الكمبيوتر الخاصة بك.

3. تجهيز اللوحة الأم للتركيب

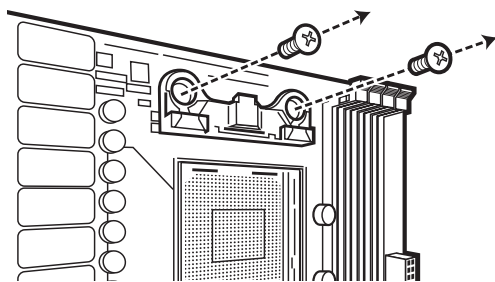

أزل كتائف التثبيت AMD AM5/AM4 الحالية كما هو موضح.

4. تركيب براغي المبعاد AMD AM5/AM4

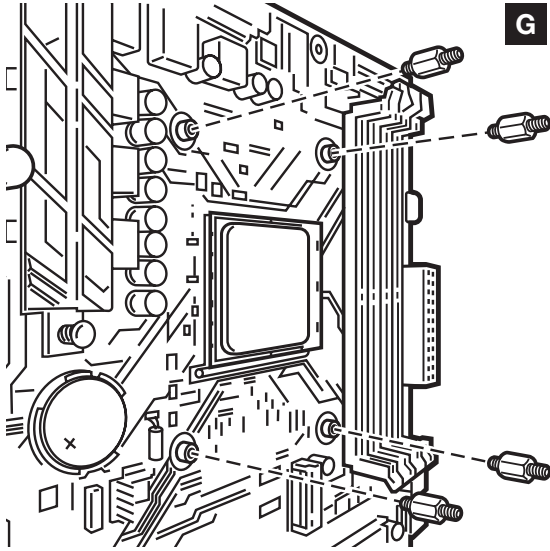





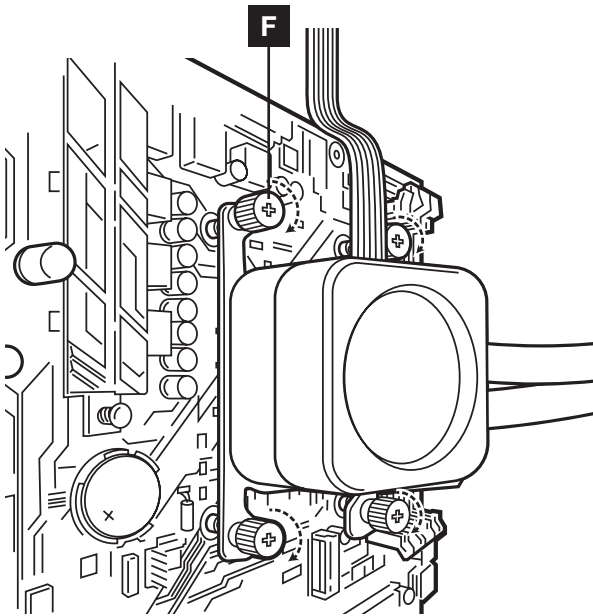

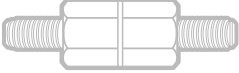

- < قم بتوصيل مبعاد AMD AM5/AM4 المرفق بمقبس وحدة المعالجة المركزية.
- < أحكم ربط كل البراغي الأربعة حتى يتم تثبيتها بشكل محكم.

5. تركيب وحدة المضخة

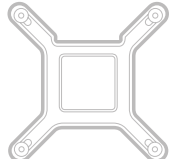
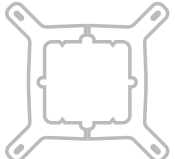
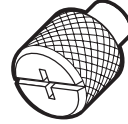

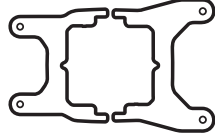
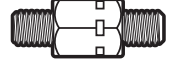
- اجعل الكتيفة محاذاة مبعادات AMD AM5/AM4 كما هو موضح. أحكم ربط الصواميل الإبهامية (F) حتى يتم تثبيتها بإحكام.

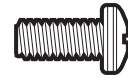
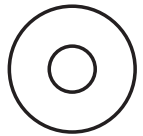
يُرجى المتابعة إلى الصفحة رقم 10 لمتابعة التركيب.

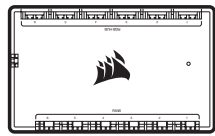
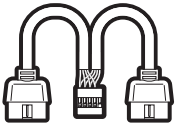
<p>A</p>  <p>4 مبادعات من نوع INTEL 1200/1150/1151/1156/1155</p>	<p>B</p>  <p>4 مبادعات من نوع INTEL 2011/2011-3/2066</p>	<p>C</p>  <p>4 مبادعات من نوع INTEL 1700</p>
<p>D</p>  <p>لوحة خلفية واحدة من INTEL</p>	<p>E</p>  <p>كثيفة تثبيت واحدة من INTEL (تم تركيبها مسبقاً)</p>	<p>F</p>  <p>4 براغي لولبية</p>
<p>G</p>  <p>4 مبادعات من النوع AMD AM5/AM4</p>	<p>H</p>  <p>كثيفة تثبيت واحدة من النوع AMD AM5/AM4</p>	<p>I</p>  <p>كثيفة تثبيت واحدة من النوع AMD sTR4/STRX4</p>
<p>J</p>  <p>4 مبادعات من النوع AMD sTR4/STRX4</p>	<p>K</p>  <p>16 برغماً طويلاً للمروحة (H100i) 24 برغماً طويلاً للمروحة (H150i/H170i)</p>	<p>L</p>  <p>8 براغي للمبرد (H100i) 12 برغماً للمبرد (H150i/H170i)</p>
<p>M</p>  <p>8 فلكات (H100i) 12 فلكة (H150i/H170i)</p>	<p>N</p>  <p>2 مروحتان (H100i) AF RGB ELITE 3 مراوح (H150i/H170i) AF RGB ELITE FANS</p>	<p>O</p>  <p>COMMANDER CORE</p>
<p>P</p>  <p>وحدة توزيع Y للتوصيل عبر USB</p>		

1. عناصر مخصصة لتثبيت sTRX4 من AMD فقط

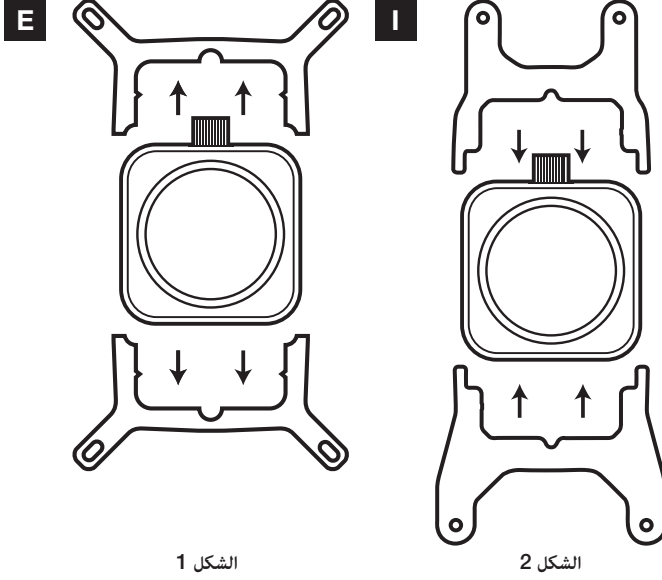

- < أزل كتيفة التثبيت المدمجة من Intel (الشكل 1).
- < ركب كتيفة AMD sTRX4 عن طريق إدخال كلا الجانبين في الفتحة الموجودة على المضخة حتى يتم تثبيتهما بإحكام (الشكل 2).

ملحوظة: من المهم عدم إحكام ربط كتيفة الاحتجاز AMD sTRX4 تمامًا على جميع الجوانب قبل التركيب.

2. تركيب براغي مبادئ sTRX4 من AMD

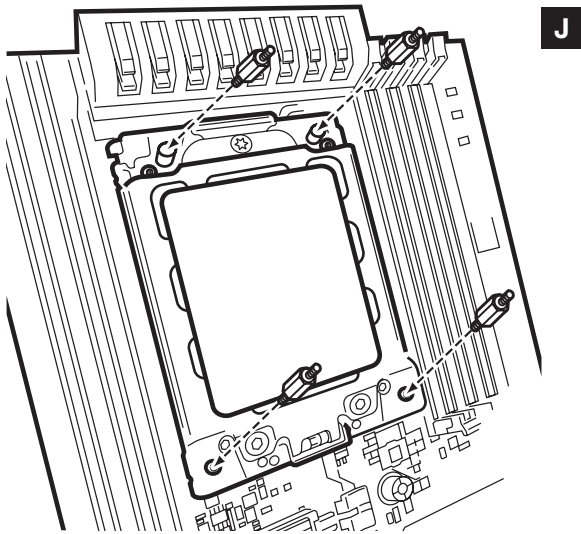

- < قم بتوصيل مبادئ AMD sTRX4 المرفقة بمقبس وحدة المعالجة المركزية.
- < أحكم ربط كل البراغي الأربعة حتى يتم تثبيتها بشكل محكم.

3. تركيب المراوح والمبرد

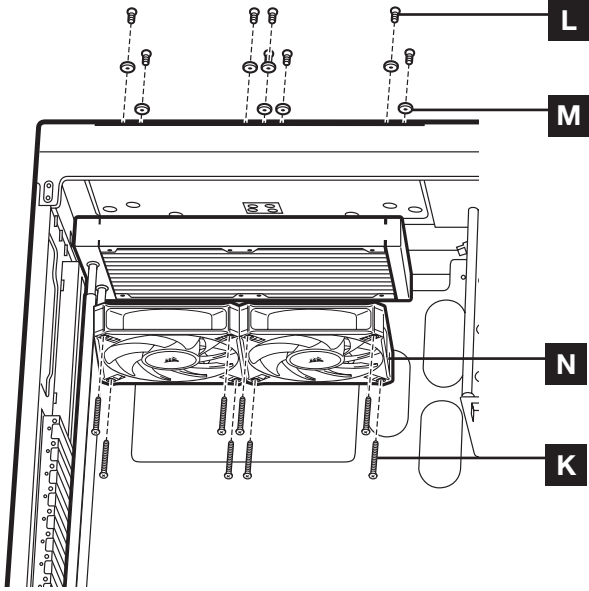

قم بتوصيل المبرد والمراوح كما هو موضح. للحصول على أفضل أداء للتبريد، نوصي بتثبيت المراوح كمدخل هواء بعلبة الكمبيوتر الخاصة بك.

4. تركيب وحدة المضخة

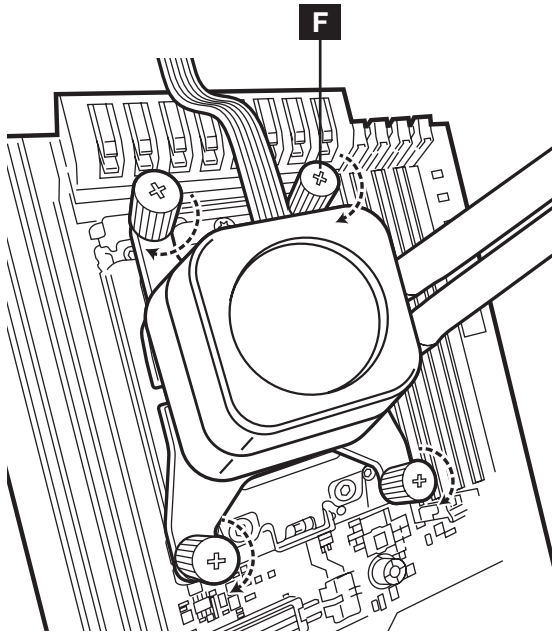

- < اجعل الكتيفة محاذاة المضخة على براغي المبعاد كما هو موضح.
- < ركب الصواميل الإبهامية (F) ببراهي المبعاد كما هو موضح.
- < أحكم ربط البراهي الإبهامية حتى يتم تثبيت كل الزوايا الأربع تمامًا.

يُرجى المتابعة إلى الصفحة رقم 10 لمتابعة التركيب.

صِل المراوح والمضخة بوحدة COMMANDER CORE

- < صِل كابل المضخة المكون من 24 سنًا بوحدة COMMANDER CORE (الشكل 1).
- < صِل كابل مقياس سرعة دوران المضخة برأس CPU_FAN في اللوحة الأم الخاصة بك (الشكل 2).
- < صِل كل المراوح بوحدة COMMANDER CORE (الشكل 3).
- < صِل كل سلك من أسلاك RGB الموجودة في المروحة بوحدة COMMANDER CORE (الشكل 3).

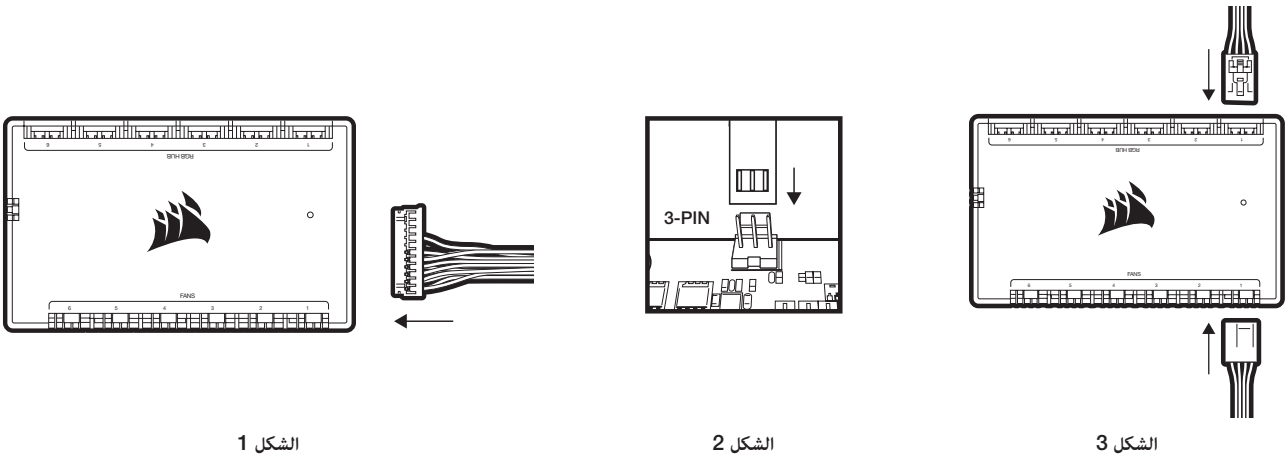

صِل وحدة COMMANDER CORE ووحدة ELITE LCD XT برأس USB 2.0 ومخرج الطاقة

- < باستخدام كابل USB المرفق، صِل وحدة COMMANDER CORE برأس USB 2.0 في اللوحة الأم.
- < صِل كابل الطاقة الخاص بالمضخة بمقبس طاقة SATA المتوفر من مصدر الطاقة الخاص بك.
- < استخدم مقسّم Y للتوصيل عبر USB من أجل تقليل عدد منافذ USB المطلوبة من 2 إلى 1.

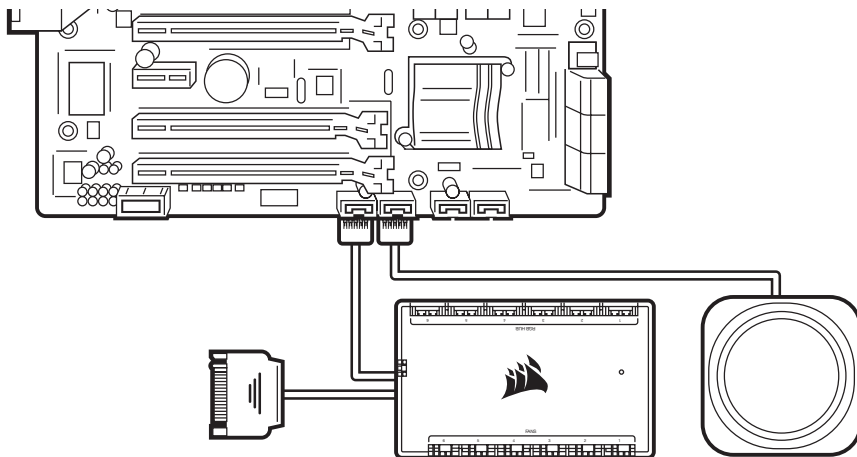

الأسئلة المتكررة

1. كيف يمكنني معرفة اتجاه تدفق هواء المروحة؟
يوجد سهم على جانب المروحة يشير إلى اتجاه تدفق الهواء.
2. هل يمكنني إعادة استخدام المعجون الحراري الذي تم وضعه مسبقاً على المبرد لإعادة تركيبه؟
ستتطلب منك عملية إعادة تركيب المبرد إزالة المعجون الحراري الذي تم وضعه مسبقاً واستعمال المعجون الحراري XTM70 (يُباع على حدة).
3. في أي اتجاه يجب عليّ تركيب المبرد؟
تتمثل أفضل طريقة لتركيب المبرد في تركيبه مع الأنابيب الموجودة أسفل العلبة، على الرغم من أنه يمكنك تركيبه مع الأنابيب في أي موضع، بما في ذلك المبرد المقلوب، طالما أن أعلى نقطة في المبرد أعلى بشكل واضح من مضخة وحدة المعالجة المركزية.

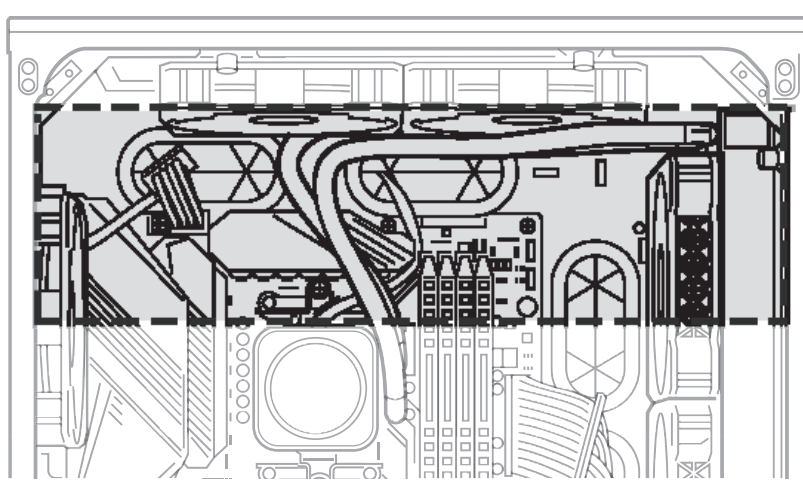

4. المبرد والمراوح تومض باللون الأحمر أو لا تعمل. ما الحل؟
يُرجى التحقق جيداً من جميع الوصلات من المبرد والمراوح إلى وحدة التحكم Commander Core. تأكد من أن وحدة التحكم Commander Core ووحدة LCD مُحدثتان بأخر برنامج ثابت من خلال برنامج iCUE. إن لم تُحل المشكلة بتلك الطريقة، يُرجى فتح تذكرة دعم على الرابط support.corsair.com أو التواصل مع فريق دعم العملاء لدينا من أجل الحصول على الدعم اللازم واستكشاف الأخطاء وإصلاحها.

<https://help.corsair.com/hc/en-us/requests/new>

5. ما الذي ينبغي القيام به إذا كانت اللوحة الخلفية للمبرد تبدو غير محكمة بعد تركيبها؟
من الشائع أن تبدو اللوحة الخلفية للمبرد غير محكمة بعد تركيبها في اللوحة الأم لأول مرة. بمجرد أن تحكم ربط مضخة المبرد، ستسحب اللوحة الخلفية نحو اللوحة الأم وتضغط على المقبس عبر المبرد.

مهم: مهما كانت الظروف، لا تضع فلكات أو فواصل إضافية على اللوحة الخلفية لتقلل من التخلخل في اللوحة. سيؤدي ذلك إلى زيادة الضغط المتزايد على مجموعة التثبيت وقد يتلفها هي أو اللوحة الأم أو المقبس.



Web: corsair.com

Phone: (888) 222-4346

Warranty: corsair.com/support/warranty

Support: support.corsair.com

Blog: corsair.com/blog

Forum: forum.corsair.com

YouTube: youtube.com/corsairhowto

© 2023 **CORSAIR MEMORY, Inc.** All rights reserved. CORSAIR and the sails logo are registered trademarks of CORSAIR in the United States and/or other countries. All other trademarks are the property of their respective owners. Product may vary slightly from those pictured.

49-002654 AB



K R-R-CSI-RWF0048
R-R-CSI-RWF0070
R-R-CSI-RWF0077
R-R-CSI-RWF0078
R-R-CSI-RWF0085